

Alternating Current (AC)

TOPIC 1

AC-Circuits and Power in AC-Circuits

- 01** An inductor of inductance L , a capacitor of capacitance C and a resistor of resistance R are connected in series to an AC source of potential difference V volts as shown in figure.

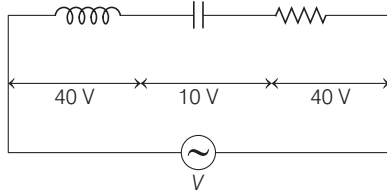

Potential difference across L , C and R is 40 V , 10 V and 40 V , respectively. The amplitude of current flowing through L - C - R series circuit is $10\sqrt{2}\text{ A}$. The impedance of the circuit is

[NEET 2021]

- (a) $4\sqrt{2}\ \Omega$ (b) $5\sqrt{2}\ \Omega$
 (c) $4\ \Omega$ (d) $5\ \Omega$

Ans. (d)

The given circuit diagram as shown below

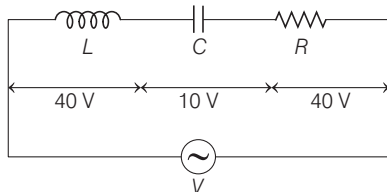

Given,

$$V_L = 40\text{ V}, V_C = 10\text{ V} \text{ and } V_R = 40\text{ V}$$

The amplitude of the current flowing in the L - C - R series circuit,

$$I_0 = 10\sqrt{2}\text{ A} \quad \dots(i)$$

We know that, rms current in the L - C - R series circuit,

$$I_{\text{rms}} = \frac{I_0}{\sqrt{2}}$$

$$\Rightarrow I_{\text{rms}} = \frac{10\sqrt{2}}{\sqrt{2}} \quad [\text{from Eq. (i)}]$$

$$\Rightarrow I_{\text{rms}} = 10\text{ A}$$

$$\therefore V_{\text{rms}} = \sqrt{V_R^2 + (V_L - V_C)^2}$$

$$\Rightarrow V_{\text{rms}} = \sqrt{(40)^2 + (40 - 10)^2}$$

$$\Rightarrow V_{\text{rms}} = 50\text{ V}$$

The impedance of the L - C - R series circuit,

$$Z = \frac{V_{\text{rms}}}{I_{\text{rms}}} \Rightarrow Z = \frac{50\text{ V}}{10\text{ A}} \text{ or } Z = 5\ \Omega$$

- 02** A series L - C - R circuit containing 5.0 H inductor, $80\ \mu\text{F}$ capacitor and $40\ \Omega$ resistor is connected to 230 V variable frequency AC source. The angular frequencies of the source at which power transferred to the circuit is half the power at the resonant angular frequency are likely to be
- [NEET 2021]

- (a) 25 rad/s and 75 rad/s
 (b) 50 rad/s and 25 rad/s
 (c) 46 rad/s and 54 rad/s
 (d) 42 rad/s and 58 rad/s

Ans. (c)

Given, in the L - C - R series circuit, $L = 5\text{ H}$

$$C = 80\ \mu\text{F}, R = 40\ \Omega$$

Supply voltage, $V = 230\text{ V}$

We know that, resonance frequency,

$$\omega_r = \frac{1}{\sqrt{LC}}$$

Substituting the values in the above equation, we get

$$\omega_r = \frac{1}{\sqrt{5 \times 80 \times 10^{-6}}} = 50\text{ rad/s}$$

Therefore, the angular frequencies of the source at which power transferred to the circuit is half the power at the resonant angular frequency are

$$\omega = \omega_r \pm \Delta\omega \quad \dots(i)$$

We know that,

$$\Delta\omega = \frac{R}{2L} \Rightarrow \Delta\omega = \frac{40}{2(5)} \Rightarrow \Delta\omega = 4$$

Using the Eq. (i), we get

$$\omega = \omega_r \pm \Delta\omega$$

$$\omega = (50 \pm 4)\text{ rad/s}$$

So, the angular frequency is likely to be 46 rad/s and 54 rad/s .

- 03** A series L - C - R circuit is connected to an AC voltage source. When L is removed from the circuit, the phase difference between current and voltage is $\frac{\pi}{3}$. If instead C is removed from the circuit, the phase difference is again $\frac{\pi}{3}$ between current and voltage. The power factor of the circuit is

[NEET (Sep.) 2020]

- (a) 0.5 (b) 1.0
 (c) -1.0 (d) zero

Ans. (b)

For L - C - R circuit, phase difference,

$$\phi = \tan^{-1}\left(\frac{X_L - X_C}{R}\right)$$

When L is removed, then $X_L = 0$

$$\therefore \phi = \tan^{-1}\left(\frac{-X_C}{R}\right)$$

$$\Rightarrow \tan\phi = \left|\frac{X_C}{R}\right| \quad \dots(i)$$

When C is removed, then $X_C = 0$

$$\therefore \phi = \tan^{-1}\left(\frac{X_L}{R}\right)$$

$$\Rightarrow \tan\phi = \frac{X_L}{R} \quad \dots(ii)$$

From Eqs. (i) and (ii), we get

$$\begin{aligned} X_L &= X_C \\ \therefore \text{Impedance, } Z &= \sqrt{R^2 + (X_L - X_C)^2} \\ &= R \end{aligned}$$

$$\text{Power factor, } \cos\phi = \frac{R}{Z} = \frac{R}{R} = 1$$

Hence, correct option is (b).

- 04** A $40\ \mu\text{F}$ capacitor is connected to a $200\ \text{V}$, $50\ \text{Hz}$ AC supply. The rms value of the current in the circuit is, nearly **[NEET (Sep.) 2020]**

- (a) $2.05\ \text{A}$ (b) $2.5\ \text{A}$
(c) $25.1\ \text{A}$ (d) $1.7\ \text{A}$

Ans. (b)

Given, $C = 40\ \mu\text{F} = 40 \times 10^{-6}\ \text{F}$

$$V_{\text{rms}} = 200\ \text{V}$$

$$\nu = 50\ \text{Hz}$$

$$\text{As, } X_C = \frac{1}{2\pi\nu C}$$

$$= \frac{1}{2\pi \times 50 \times 40 \times 10^{-6}}$$

$$= \frac{10^6}{100\pi \times 40} = \frac{250}{\pi}\ \Omega$$

$$\therefore I_{\text{rms}} = \frac{V_{\text{rms}}}{X_C} = \frac{200}{\left(\frac{250}{\pi}\right)} = 2.5\ \text{A}$$

Hence, correct option is (b).

- 05** The variation of EMF with time for four types of generators are shown in the figures. Which amongst them can be called AC? **[NEET (Odisha) 2019]**

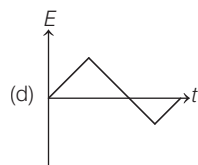
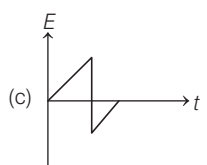
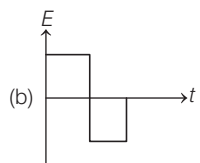
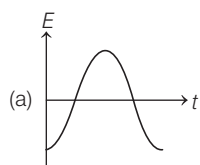

Ans. (b)

The emf generated due to a rotating conductor in a generator is given by

$$E = -\frac{d\phi_b}{dt}$$

where, ϕ_b = magnetic flux linked with conductor

From the above equation we can conclude that the emf generated is a varying function of time with opposite polarity. So, all the graph are correct for the given variations.

- 06** A circuit when connected to an AC source of $12\ \text{V}$ gives a current of $0.2\ \text{A}$. The same circuit when connected to a DC source of $12\ \text{V}$, gives a current of $0.4\ \text{A}$. The circuit is **[NEET (Odisha) 2019]**

- (a) series LR (b) series RC
(c) series LC (d) series LCR

Ans. (a)

When the circuit is connected to AC source,

$$\text{Voltage, } V = 12\ \text{V}$$

$$\text{Current, } I = 0.2\ \text{A}$$

$$\Rightarrow \text{Impedance } Z = \frac{V}{I} = \frac{12}{0.2} = 60\ \Omega$$

When it is connected to DC source,

$$\text{Voltage, } V = 12\ \text{V}$$

$$\text{Current, } I = 0.4\ \text{A}$$

$$\Rightarrow \text{Resistance, } R = \frac{V}{I} = \frac{12}{0.4} = 30\ \Omega$$

As in case of DC supply, the capacitor act as an open circuit and no current flows through the circuit. So the given circuit will not have capacitor in series combination. Therefore the circuit should be a series L-R circuit.

- 07** Figure shows a circuit that contains three identical resistors with resistance $R = 9.0\ \Omega$ each, two identical inductors with inductance $L = 2.0\ \text{mH}$ each, and an ideal battery with emf $\varepsilon = 18\ \text{V}$. The current i through the battery just after the switch closed is **[NEET 2017]**

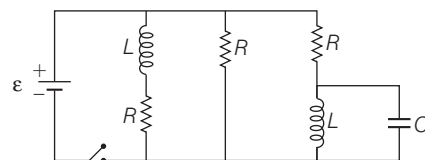

- (a) $2\ \text{mA}$ (b) $0.2\ \text{A}$
(c) $2\ \text{A}$ (d) $0\ \text{A}$

Ans. (*)

No option is matching.

Thinking Process Just after switch is closed, inductor acts like an open switch (open path) and capacitor acts like a closed switch (closed path) because in D.C. circuit inductive resistance becomes zero.

Just after switch is closed, given circuit is equivalent to the circuit shown below.

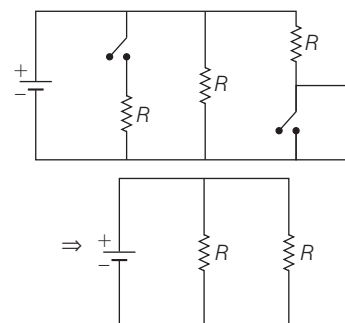

So, equivalent resistor

$$= \frac{R}{2} = \frac{9}{2}\ \text{ohms}$$

Battery emf, $V = 18\ \text{volts}$

$$\therefore \text{Current in circuit} = \frac{V}{R} = \frac{18 \times 2}{9} = 4\ \text{A}$$

- 08** In an electromagnetic wave in free space the root mean square value of the electric field is $E_{\text{rms}} = 6\ \text{V/m}$. The peak value of the magnetic field is **[NEET 2017]**

- (a) $1.41 \times 10^{-8}\ \text{T}$ (b) $2.83 \times 10^{-8}\ \text{T}$
(c) $0.70 \times 10^{-8}\ \text{T}$ (d) $4.23 \times 10^{-8}\ \text{T}$

Ans. (b)

Given, root mean square value of electric field,

$$E_{\text{rms}} = 6\ \text{V/m}$$

We know that, peak value of electric field,

$$E_0 = \sqrt{2} E_{\text{rms}}$$

$$\Rightarrow E_0 = \sqrt{2} \times 6\ \text{V/m}$$

$$\text{Also, we know that, } c = \frac{E_0}{B_0}$$

where, c = speed of light in vacuum
 B_0 = peak value of magnetic field

$$\Rightarrow B_0 = \frac{E_0}{c} \Rightarrow B_0 = \frac{\sqrt{2} \times 6}{3 \times 10^8}$$

$$\Rightarrow B_0 = \frac{8.48}{3} \times 10^{-8}$$

$$\Rightarrow B_0 = 2.83 \times 10^{-8} \text{ T}$$

09 A small signal voltage $V(t) = V_0 \sin \omega t$ is applied across an ideal capacitor C [NEET 2016]

- (a) over a full cycle the capacitor C does not consume any energy from the voltage source
 (b) current $I(t)$ is in phase with voltage $V(t)$
 (c) current $I(t)$ leads voltage $V(t)$ by 180°
 (d) current $I(t)$, lags voltage $V(t)$ by 90°

Ans. (a)

For an AC circuit containing capacitor only, the phase difference between current and voltage will be $\frac{\pi}{2}$ (i.e. 90°).

In this case current is ahead of voltage by $\frac{\pi}{2}$.

Hence, power in this case is given by

$$P = VI \cos \phi$$

(ϕ = phase difference between voltage and current)

$$P = VI \cos 90^\circ = 0$$

10 An inductor 20 mH , a capacitor $50 \mu\text{F}$ and a resistor 40Ω are connected in series across a source of emf $V = 10 \sin 340 t$. The power loss in AC circuit is [NEET 2016]

- (a) 0.67 W (b) 0.76 W
 (c) 0.89 W (d) 0.51 W

Ans. (d)

Given,

Inductance $L = 20 \text{ mH}$

Capacitance, $C = 50 \mu\text{F}$

Resistance, $R = 40 \Omega$

emf, $V = 10 \sin 340 t$

\therefore Power loss in AC circuit will be given as

$$P_{av} = I_v^2 R = \left[\frac{E_v}{Z} \right]^2 \cdot R$$

$$= \left(\frac{10}{\sqrt{2}} \right)^2 \cdot 40 \cdot \frac{1}{40^2 + \left(\frac{340 \times 20 \times 10^{-3} - 1}{340 \times 50 \times 10^{-6}} \right)^2}$$

$$= \frac{100}{2} \times 40 \times \frac{1}{1600 + (6.8 - 58.8)^2}$$

$$= \frac{2000}{1600 + 2704} \approx 0.46 \text{ W} \approx 0.51 \text{ W}$$

11 Which of the following combinations should be selected for better tuning of an L - C - R circuit used for communication? [NEET 2016]

- (a) $R = 20 \Omega, L = 1.5 \text{ H}, C = 35 \mu\text{F}$
 (b) $R = 25 \Omega, L = 2.5 \text{ H}, C = 45 \mu\text{F}$
 (c) $R = 15 \Omega, L = 3.5 \text{ H}, C = 30 \mu\text{F}$
 (d) $R = 25 \Omega, L = 1.5 \text{ H}, C = 45 \mu\text{F}$

Ans. (c)

Key Idea For better tuning, peak of current growth must be sharp. This is ensured by a high value of quality factor Q .

Now, quality factor is given by $Q = \frac{1}{R} \sqrt{\frac{L}{C}}$

From the given options, highest value of Q is associated with $R = 15 \Omega$, $L = 3.5 \text{ H}$ and $C = 30 \mu\text{F}$

12 The potential differences across the resistance, capacitance and inductance are 80 V , 40 V and 100 V respectively in an L - C - R circuit. The power factor of this circuit is [NEET 2016]

- (a) 0.4 (b) 0.5
 (c) 0.8 (d) 1.0

Ans. (c)

Power factor of the L - C - R circuit

$$= \cos \phi = \frac{R}{Z}$$

$$= \frac{IR}{IZ} = \frac{80}{I \sqrt{(X_L - X_C)^2 + R^2}}$$

$$= \frac{80}{\sqrt{(IX_L - IX_C)^2 + (IR)^2}}$$

$$= \frac{80}{\sqrt{(100 - 40)^2 + (80)^2}}$$

$$= \frac{80}{\sqrt{(60)^2 + (80)^2}} = \frac{80}{100} = 0.8$$

13 A 100Ω resistance and a capacitor of 100Ω reactance are connected in series across a 220 V source.

When the capacitor is 50% charged, the peak value of the displacement current is [NEET 2016]

- (a) 2.2 A (b) 11 A
 (c) 4.4 A (d) $11\sqrt{2} \text{ A}$

Ans. (a)

Impedance of the R - C circuit,

$$Z = \sqrt{R^2 + X_c^2}$$

where, $R = 100 \Omega$ and $X_c = 100 \Omega$

$$\Rightarrow \tau = \sqrt{(100)^2 + (100)^2} = 100\sqrt{2} \Omega$$

Peak value of the current,

$$I_{\max} = \frac{V_{\max}}{Z} = \frac{220\sqrt{2}}{100\sqrt{2}} = 2.2 \text{ A}$$

14 A resistance ' R ' draws power ' P ' when connected to an AC source. If an inductance is now placed in series with the resistance, such that the impedance of the circuit becomes ' Z ' the power drawn will be [CBSE AIPMT 2015]

- (a) $P \left(\frac{R}{Z} \right)^2$ (b) $P \frac{R}{Z}$
 (c) $P \left(\frac{R}{Z} \right)$ (d) P

Ans. (a)

When a resistor is connected to an AC source. The power drawn will be

$$P = V_{\text{rms}} \cdot I_{\text{rms}} = V_{\text{rms}} \cdot \frac{V_{\text{rms}}}{R} \Rightarrow V_{\text{rms}}^2 = PR$$

When an inductor is connected in series with the resistor, then the power drawn will be

$$P' = V_{\text{rms}} \cdot I_{\text{rms}} \cos \phi$$

where, ϕ = phase difference

$$\therefore P' = \frac{V_{\text{rms}}^2}{R} \cdot \frac{R^2}{Z^2} = P \cdot R \cdot \frac{R}{Z^2}$$

$$\Rightarrow P' = \frac{P \cdot R^2}{Z^2} = P \left(\frac{R}{Z} \right)^2$$

15 A series R - C circuit is connected to an alternating voltage source. Consider two situations : [CBSE AIPMT 2015]

- When capacitor is air filled.
- When capacitor is mica filled.

Current through resistor is i and voltage across capacitor is V then

- (a) $V_a < V_b$ (b) $V_a > V_b$
 (c) $i_a > i_b$ (d) $V_a = V_b$

Ans. (b)

Net reactive capacitance,

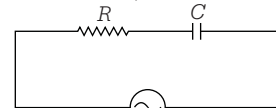

$$V = V_0 \sin \omega t$$

$$X_c = \frac{1}{2\pi fC}$$

So, current in circuit, $I = \frac{V}{Z}$

$$= \frac{V}{\sqrt{R^2 + \left(\frac{1}{2\pi fC} \right)^2}}$$

$$\Rightarrow I = \frac{2\pi f C}{\sqrt{4\pi^2 f^2 C^2 R^2 + 1}} \times V$$

Voltage drop across capacitor,

$$V_c = I \times X_c$$

$$= \frac{2\pi f C}{\sqrt{4\pi^2 f^2 C^2 R^2 + 1}} \times \frac{1}{2\pi f C}$$

$$\text{i.e. } V_c = \frac{V}{\sqrt{4\pi^2 f^2 C^2 R^2 + 1}}$$

When mica is introduced, capacitance will increase hence, voltage across capacitor get decrease.

- 16** A coil of self-inductance L is connected in series with a bulb B and an AC source. Brightness of the bulb decreases when
[NEET 2013]

- (a) frequency of the AC source is decreased
(b) number of turns in the coil is reduced
(c) a capacitance of reactance $X_c = X_L$ is included in the same circuit
(d) an iron rod is inserted in the coil

Ans. (d)

When a bulb of resistance R is connected in series with a coil of self-inductance L , then current in the circuit is given by

$$I = \frac{E}{\sqrt{\omega^2 L^2 + R^2}}, \text{ where } E \text{ is the}$$

voltage of an AC source

$$\text{As } L = \frac{\mu_0 \mu_r N^2 A}{l}$$

$$\Rightarrow L \propto \mu_r$$

When iron rod is inserted, L increases, therefore current I decreases.

- 17** In an electrical circuit, R, L, C and an AC voltage source are all connected in series. When L is removed from the circuit, the phase difference between the voltage and the current in the circuit is $\pi/3$. If instead, C is removed from the circuit, the phase difference is again $\pi/3$. The power factor of the circuit is
(a) $1/2$ [CBSE AIPMT 2012]
(b) $1/\sqrt{2}$
(c) 1
(d) $\sqrt{3}/2$

Ans. (c)

As we know that phase difference for L, C, R series circuit is given by

$$\tan \phi = \frac{X_L - X_C}{R}$$

When L is removed $\tan \frac{\pi}{3} = \frac{X_C}{R}$

$$\sqrt{3} = \frac{X_C}{R}$$

$$\Rightarrow X_C = R\sqrt{3}$$

When C is removed, $\tan \frac{\pi}{3} = \sqrt{3} = \frac{X_L}{R}$

$$\Rightarrow X_L = R\sqrt{3}$$

Hence, in resonant circuit

$$\tan \phi = \frac{\sqrt{3}R - \sqrt{3}R}{R} = 0$$

So, $\phi = 0$

Power factor, $\cos \phi = 1$

It is the condition of resonance, therefore, phase difference between voltage and current is zero and power factor, $\cos \phi = 1$.

- 18** In an AC circuit an alternating voltage $e = 200\sqrt{2} \sin 100t$ volt is connected to a capacitor of capacity $1\mu\text{F}$. The rms value of the current in the circuit is [CBSE AIPMT 2011]

- (a) 100 mA (b) 200 mA
(c) 20 mA (d) 10 mA

Ans. (c)

Problem Solving Strategy Compare the given equation with the equation of alternating voltage i.e.

$$e = e_m \sin \omega t$$

where, $e_m = e_{\text{rms}}$

Given,

$$\text{emf, } e = 200\sqrt{2} \sin 100t$$

$$\text{and } C = 1\mu\text{F} = 1 \times 10^{-6}\text{F}$$

$$\text{As } e_{\text{rms}} = 200\text{V and } \omega = 100$$

$$\therefore X_C = \frac{1}{\omega C} = \frac{1}{1 \times 10^{-6} \times 100} = 10^4 \Omega$$

$$i_{\text{rms}} = \frac{e_{\text{rms}}}{X_C}$$

$$= \frac{200}{10^4} = 2 \times 10^{-2} \text{ A} = 20 \text{ mA}$$

- 19** An AC voltage is applied to a resistance R and an inductor L in series. If R and the inductive reactance are both equal to 3Ω , the phase difference between the applied voltage and the current in the circuit is [CBSE AIPMT 2011]
(a) $\pi/4$ (b) $\pi/2$
(c) zero (d) $\pi/6$

Ans. (a)

As we know that

$$\tan \phi = \frac{X_L}{R} = \frac{\omega L}{R} \Rightarrow \tan \phi = \frac{3}{3}$$

$$\therefore \tan \phi = 1 \Rightarrow \phi = 45^\circ$$

So, phase difference = $\frac{\pi}{4}$ rad

- 20** In the given circuit, the reading of voltmeter V_1 and V_2 are 300 V each. The reading to the voltmeter V_3 and ammeter A are respectively [CBSE AIPMT 2010]

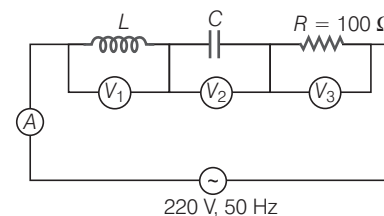

- (a) 150 V, 2.2 A (b) 220 V, 2.2 A
(c) 220 V, 2.0 A (d) 100 V, 2.0 A

Ans. (b)

For series LCR circuit

$$\text{Voltage } V = \sqrt{V_R^2 + (V_L - V_C)^2}$$

Since, $V_L = V_C$

$$\text{Hence } V = V_R = 220 \text{ V}$$

$$\text{Also, current } i = \frac{V}{R} = \frac{220}{100} = 2.2 \text{ A}$$

- 21** Power dissipated in an $L-C-R$ series circuit connected to an AC source of emf ϵ is [CBSE AIPMT 2009]

$$(a) \frac{\epsilon^2 R}{R^2 + \left(L\omega - \frac{1}{C\omega}\right)^2}$$

$$(b) \frac{\epsilon^2 \sqrt{R^2 + \left(L\omega - \frac{1}{C\omega}\right)^2}}{R}$$

$$(c) \frac{\epsilon^2 \left[R^2 + \left(L\omega - \frac{1}{C\omega}\right)^2\right]}{R}$$

$$(d) \frac{\epsilon^2 R}{\sqrt{R^2 + \left(L\omega - \frac{1}{C\omega}\right)^2}}$$

Ans. (a)

Power dissipated in series LCR.

$$P = I_{\text{rms}}^2 R = \frac{\epsilon_{\text{rms}}^2 R}{|Z|^2} = \frac{\epsilon^2 R}{R^2 + \left(\omega L - \frac{1}{\omega C}\right)^2}$$

$$\text{As } I_{\text{rms}} = \frac{V_{\text{rms}}}{Z}$$

- 22** What is the value of inductance L for which the current is maximum in a series LCR circuit with $C = 10 \mu\text{F}$ and $\omega = 1000 \text{ s}^{-1}$?

[CBSE AIPMT 2007]

- (a) 100 mH
 (b) 1 mH
 (c) Cannot be calculated unless R is known
 (d) 10 mH

Ans. (a)

Current in LCR series circuit,

$$i = \frac{V}{\sqrt{R^2 + (X_L - X_C)^2}}$$

where, V is rms value of voltage R is resistance, X_L is inductive reactance and X_C is capacitive reactance.

For current to be maximum, denominator should be minimum which can be done, i.e. during the resonance of series LCR circuit

$$X_L = X_C \quad \text{i.e.} \quad \omega L = \frac{1}{\omega C}$$

or $L = \frac{1}{\omega^2 C} \quad \dots(i)$

Given, $\omega = 1000 \text{ s}^{-1}$, $C = 10 \mu\text{F} = 10 \times 10^{-6} \text{ F}$

Hence, $L = \frac{1}{(1000)^2 \times 10 \times 10^{-6}} = 0.1 \text{ H} = 100 \text{ mH}$

- 23** A coil of inductive reactance 31Ω has a resistance of 8Ω . It is placed in series with a condenser of capacitive reactance 25Ω . The combination is connected to an AC source of 110 V . The power factor of the circuit is

[CBSE AIPMT 2006]

- (a) 0.56 (b) 0.64
 (c) 0.80 (d) 0.33

Ans. (c)

Power factor of AC circuit is given by

$$\cos \phi = \frac{R}{Z} \quad \dots(i)$$

where, R is resistance and Z is the impedance of the circuit and is given by

$$Z = \sqrt{R^2 + (X_L - X_C)^2} \quad \dots(ii)$$

X_L = inductive reactance

X_C = capacitive reactance

Eqs. (i) and (ii) meet to give,

$$\cos \phi = \frac{R}{\sqrt{R^2 + (X_L - X_C)^2}} \quad \dots(iii)$$

Given, $R = 8 \Omega$, $X_L = 31 \Omega$, $X_C = 25 \Omega$

$$\cos \phi = \frac{8}{\sqrt{(8)^2 + (31 - 25)^2}} = \frac{8}{\sqrt{64 + 36}}$$

Hence, $\cos \phi = 0.80$

- 24** In a circuit, L , C and R are connected in series with an alternating voltage source of frequency f . The current leads the voltage by 45° . The value of C is

[CBSE AIPMT 2005]

- (a) $\frac{1}{2\pi f(2\pi fL + R)}$
 (b) $\frac{1}{\pi f(2\pi fL + R)}$
 (c) $\frac{1}{2\pi f(2\pi fL - R)}$
 (d) $\frac{1}{\pi f(2\pi fL - R)}$

Ans. (c)

Phase difference between current and voltage in LCR series circuit is given by

$$\tan \phi = \frac{\omega L - \frac{1}{\omega C}}{R}$$

$$\left[\begin{array}{l} \omega L = \text{inductive reactance} \\ \frac{1}{\omega C} = \text{capacitive reactance} \end{array} \right]$$

ϕ being the angle by which the current leads the voltage.

Given,

$$\phi = 45^\circ$$

$$\therefore \tan 45^\circ = \frac{\omega L - \frac{1}{\omega C}}{R}$$

$$\Rightarrow 1 = \frac{\omega L - \frac{1}{\omega C}}{R}$$

$$\Rightarrow R = \omega L - \frac{1}{\omega C}$$

$$\Rightarrow \omega C = \frac{1}{(\omega L - R)}$$

$$\Rightarrow C = \frac{1}{\omega(\omega L - R)}$$

$$= \frac{1}{2\pi f(2\pi fL - R)}$$

- 25** For a series LCR circuit, the power loss at resonance is

[CBSE AIPMT 2002]

- (a) $\frac{V^2}{\omega L - \frac{1}{\omega C}}$ (b) $i^2 C \omega$
 (c) $i^2 R$ (d) $\frac{V^2}{\omega C}$

Ans. (c)

In series LCR circuit at resonance, capacitive reactance (X_C) = inductive reactance (X_L)

$$\text{i.e.} \quad \frac{1}{\omega C} = \omega L$$

Total impedance of the circuit

$$Z = \sqrt{R^2 + (X_L - X_C)^2} = \sqrt{R^2 + \left(\omega L - \frac{1}{\omega C}\right)^2}$$

$$\text{i.e.} \quad Z = R$$

$$\text{So, power factor, } \cos \phi = \frac{R}{Z} = \frac{R}{R} = 1$$

Thus, power loss at resonance is given by

$$\begin{aligned} P &= V_{\text{rms}} i_{\text{rms}} \cos \phi \quad [\cos \phi = 1] \\ &= V_{\text{rms}} i_{\text{rms}} \times 1 \\ &= (i_{\text{rms}} R) i_{\text{rms}} \\ &= (i_{\text{rms}})^2 R = i^2 R \end{aligned}$$

- 26** The reactance of a capacitor of capacitance C is X . If both the frequency and capacitance be doubled, then new reactance will be

[CBSE AIPMT 2001]

- (a) X (b) $2X$ (c) $4X$ (d) $\frac{X}{4}$

Ans. (d)

If a capacitor of capacitance C is connected with an AC signal, then reactance of that circuit is purely capacitive.

The capacitive reactance is

$$X = \frac{1}{\omega C} = \frac{1}{2\pi f C} \quad (\omega = 2\pi f)$$

$$\text{or} \quad X \propto \frac{1}{fC}$$

Considering two different situations of frequency and capacitance, we have

$$\frac{X'}{X} = \frac{fC}{f'C'} = \frac{f \times C}{2f \times 2C}$$

$$[\because f' = 2f \text{ and } C' = 2C]$$

$$\text{or} \quad \frac{X'}{X} = \frac{1}{4} \quad \text{or} \quad X' = \frac{X}{4}$$

- 27** A wire of resistance R is connected in series with an inductor of reactance ωL . Then quality factor of RL circuit is

[CBSE AIPMT 2000]

- (a) $\frac{R}{\omega L}$
 (b) $\frac{\omega L}{R}$
 (c) $\frac{R}{\sqrt{R^2 + \omega^2 L^2}}$
 (d) $\frac{\omega L}{\sqrt{R^2 + \omega^2 L^2}}$

Ans. (b)

We define the quality factor of the circuit as follows

Quality factor, Q

$$= 2\pi \times \frac{\text{total energy stored in the circuit}}{\text{loss in energy in each cycle}}$$

But the total energy stored in circuit

$$= Li_{rms}^2$$

and the energy loss per second $= i_{rms}^2 R$

$$\text{So, loss in energy per cycle} = \frac{i_{rms}^2 R}{f}$$

Hence, quality factor,

$$Q = 2\pi \times \frac{Li_{rms}^2}{i_{rms}^2 R/f} \\ = \frac{2\pi fL}{R} = \frac{\omega L}{R}$$

- 28** In a circuit inductance L and capacitance C are connected as shown in figure. A_1 and A_2 are ammeters. When key K is pressed to complete the circuit, then just after closing key (K), the reading of current will be **[CBSE AIPMT 1999]**



- (a) zero in both A_1 and A_2
 (b) maximum in both A_1 and A_2
 (c) zero in A_1 and maximum in A_2
 (d) maximum in A_1 and zero in A_2

Ans. (d)

There is no DC current in inductive circuit because it does not allow DC current to flow and maximum DC current in capacitive circuit. Hence, the current is zero in A_2 and maximum in A_1 .

- 29** In an AC circuit with voltage V and current i the power dissipated is **[CBSE AIPMT 1997]**

- (a) Depends on the phase between V and i
 (b) $\frac{1}{\sqrt{2}} Vi$
 (c) $\frac{1}{2} Vi$
 (d) Vi

Ans. (a)

In an AC circuit with voltage V and current i , the power dissipated is given by

$$P = Vi \cos \phi$$

where, ϕ is the phase and $\cos \phi$ is the power factor. Thus, the power dissipated, depends upon the phase between voltage V and current i .

- 30** In an experiment, 200 V AC is applied at the ends of an LCR circuit. The circuit consists of an inductive reactance (X_L) = 50 Ω , capacitive reactance (X_C) = 50 Ω and ohmic resistance (R) = 10 Ω . The impedance of the circuit is **[CBSE AIPMT 1996]**

- (a) 10 Ω (b) 20 Ω
 (c) 30 Ω (d) 40 Ω

Ans. (a)

Total effective resistance of LCR circuit is called impedance of the LCR series circuit. It is represented by Z .

$$\text{where } Z = \frac{V_0}{i_0} = \sqrt{R^2 + (X_L - X_C)^2}$$

Given, $V_{AC} = 200$ V

Resistance offered by inductor

$$X_L = 50 \Omega$$

Resistance offered by capacitance

$$X_C = 50 \Omega$$

$$R = 10 \Omega$$

$$Z = ?$$

$$\therefore Z = \sqrt{(10)^2 + (50 - 50)^2}$$

$$\text{or } Z = 10 \Omega$$

- 31** An LCR series circuit is connected to a source of alternating current. At resonance, the applied voltage and the current flowing through the circuit will have a phase difference of **[CBSE AIPMT 1994]**

- (a) π (b) $\frac{\pi}{2}$
 (c) $\frac{\pi}{4}$ (d) zero

Ans. (d)

A circuit in which inductance L , capacitance C and resistance R are connected in series, and the circuit admits maximum current corresponding to a given frequency of AC is called series resonance circuit. The impedance (Z) of an RLC circuit is given by

$$Z = \sqrt{R^2 + \left(\omega L - \frac{1}{\omega C}\right)^2}$$

At resonance $X_L = X_C$

$$\text{i.e. } \omega L = \frac{1}{\omega C}, Z = R$$

So, circuit behaves as if it contains R only. So, phase difference = 0.

Frequency of resonating LCR circuit is given by

$$\omega^2 = \frac{1}{LC} \Rightarrow f = \frac{1}{2\pi\sqrt{LC}}$$

- 32** In an AC circuit, the rms value of current, i_{rms} is related to the peak current, i_0 by the relation

[CBSE AIPMT 1994]

- (a) $i_{rms} = \sqrt{2} i_0$ (b) $i_{rms} = \pi i_0$
 (c) $i_{rms} = \frac{i_0}{\pi}$ (d) $i_{rms} = \frac{1}{\sqrt{2}} i_0$

Ans. (d)

Root mean square value of an alternating current is defined as the square root of the average of i^2 , during a complete cycle it may be taken by

$$\bar{i^2} = \frac{\int_0^{2\pi/\omega} i^2 dt}{\frac{2\pi}{\omega}} \\ = \frac{\int_0^{2\pi/\omega} i_0^2 \sin^2 \omega t dt}{\frac{2\pi}{\omega}} \\ = \frac{i_0^2 \omega}{2\pi} \int_0^{2\pi/\omega} \frac{1}{2} (1 - \cos 2\omega t) dt \\ = \frac{i_0^2 \omega}{4\pi} \left[t - \frac{\sin 2\omega t}{2\omega} \right]_0^{2\pi/\omega} \\ = \frac{i_0^2 \omega}{4\pi} \left(\frac{2\pi}{\omega} \right) = \frac{i_0^2}{2}$$

$$\therefore i_{rms} = \sqrt{\bar{i^2}} = \frac{i_0}{\sqrt{2}}$$

- 33** The time constant of C-R circuit is **[CBSE AIPMT 1992]**

- (a) $\frac{1}{CR}$ (b) $\frac{C}{R}$
 (c) CR (d) $\frac{R}{C}$

Ans. (c)

The quantity $\tau = CR$ is called time constant or capacitive time constant of CR circuit. This is because dimensions of RC are those of time and for a given CR circuit, its value is constant.

Alternative

$$\text{As } R = \frac{V}{i} \text{ and } C = \frac{q}{V}$$

$$\therefore RC = \frac{V}{i} \frac{q}{V} = \frac{q}{i} = \frac{i \times t}{i} = t$$

$$\therefore [RC] = [t] = [T]$$

TOPIC 2

AC Generator and Transformer

- 34** A step down transformer connected to an AC mains supply of 220 V is made to operate at 11 V, 44 W lamp. Ignoring power losses in the transformer, what is the current in the primary circuit ?

[NEET 2021]

- (a) 0.2 A (b) 0.4 A
(c) 2 A (d) 4 A

Ans. (a)

Given, the main supply line voltage in transformer,

$$V = 220 \text{ V}$$

The rating of the lamp = 11 V, 44 W

We know that,

$$P = VI_p \quad \dots(i)$$

Here, P is the power that operates the lamp,

V is the supply line voltage,

I_p is the primary current in the transformer.

From Eq. (i), we get

$$\Rightarrow 44 = I_p \times 220$$

$$\Rightarrow I_p = 0.2 \text{ A}$$

- 35** A transformer having efficiency of 90% is working on 200 V and 3 kW power supply. If the current in the secondary coil is 6 A, the voltage across the secondary coil and the current in the primary coil respectively are [CBSE AIPMT 2014]

- (a) 300 V, 15 A (b) 450 V, 15 A
(c) 450 V, 13.5 A (d) 600 V, 15 A

Ans. (b)

Initial power = 3000 W

As efficiency is 90%, then final power

$$= 3000 \times \frac{90}{100} = 2700 \text{ W}$$

$$\Rightarrow \left. \begin{aligned} V_1 I_1 &= 3000 \text{ W} \\ V_2 I_2 &= 2700 \text{ W} \end{aligned} \right\} \dots(i)$$

$$V_2 = \frac{2700}{6} = \frac{900}{2} \quad [\because I_2 = 6 \text{ A}]$$

$$\Rightarrow V_2 = 450 \text{ V}$$

$$\text{and } I_1 = \frac{3000}{200} \quad [\because V_1 = 200 \text{ V}]$$

$$\Rightarrow I_1 = 15 \text{ A}$$

- 36** A 220 V input is supplied to a transformer. The output circuit draws a current of 2.0 A at 440 V. If the efficiency of the transformer is 80%, the current drawn by the primary windings of the transformer is [CBSE AIPMT 2010]

- (a) 3.6 A (b) 2.8 A
(c) 2.5 A (d) 5.0 A

Ans. (d)

Efficiency is defined as the ratio of output power and input power

$$\text{i.e. } \eta \% = \frac{P_{\text{out}}}{P_{\text{input}}} \times 100 = \frac{V_s i_s}{V_p i_p} \times 100$$

$$80 = \frac{2 \times 440}{220 \times i_p} \times 100 \Rightarrow i_p = 5 \text{ A}$$

- 37** In an AC circuit the emf (V) and the current (i) at any instant are given respectively by

$$V = V_0 \sin \omega t,$$

$$i = i_0 \sin(\omega t - \phi)$$

The average power in the circuit over one cycle of AC is

[CBSE AIPMT 2008]

- (a) $\frac{V_0 i_0}{2}$ (b) $\frac{V_0 i_0}{2} \sin \phi$
(c) $\frac{V_0 i_0}{2} \cos \phi$ (d) $V_0 i_0$

Ans. (c)

$$P_{\text{av}} = V_{\text{rms}} \cdot i_{\text{rms}} \cos \phi = \frac{1}{2} V_0 i_0 \cos \phi$$

$$\left[\because V_{\text{rms}} = \frac{V_0}{\sqrt{2}}, i_{\text{rms}} = \frac{i_0}{\sqrt{2}} \right]$$

where, $\cos \phi =$ power factor

- 38** A transformer is used to light a 100 W and 110 V lamp from a 220 V mains. If the main current is 0.5 A, the efficiency of the transformer is approximately

[CBSE AIPMT 2007]

- (a) 30% (b) 50%
(c) 90% (d) 10%

Ans. (c)

The efficiency of transformer

$$= \frac{\text{Energy obtained from the secondary coil}}{\text{Energy given to the primary coil}}$$

$$\text{or } \eta = \frac{\text{Output power}}{\text{Input power}}$$

$$\text{or } \eta = \frac{V_s I_s}{V_p I_p} \quad [\text{as power} = VI]$$

$$\text{Given, } V_s I_s = 100 \text{ W, } V_p = 220 \text{ V, } I_p = 0.5 \text{ A}$$

$$\text{Hence, } \eta = \frac{100}{220 \times 0.5} = 0.90 = 90\%$$

- 39** The primary and secondary coils of a transformer have 50 and 1500 turns respectively. If the magnetic flux ϕ linked with the primary coil is given by $\phi = \phi_0 + 4t$, where ϕ is in weber, t is time in second and ϕ_0 is a constant, the output voltage across the secondary coil is

[CBSE AIPMT 2007]

- (a) 90 V (b) 120 V
(c) 220 V (d) 30 V

Ans. (b)

The magnetic flux linked with the primary coil is given by

$$\phi = \phi_0 + 4t$$

So, voltage across primary

$$V_p = \frac{d\phi}{dt} = \frac{d}{dt} (\phi_0 + 4t)$$

$$= 4 \text{ V} \quad (\text{as } \phi_0 = \text{constant})$$

Also, we have

$$N_p = 50 \text{ and } N_s = 1500$$

As we know that voltage across primary and secondary coil is directly proportional to the no. of turns in primary and secondary coil respectively.

$$\text{So, } \frac{V_s}{V_p} = \frac{N_s}{N_p} \text{ or } V_s = V_p \frac{N_s}{N_p}$$

$$= 4 \left(\frac{1500}{50} \right) = 120 \text{ V}$$

Note As in case of given transformer, voltage in secondary is increased, hence it is a step-up transformer.

- 40** The core of a transformer is laminated because

[CBSE AIPMT 2006]

- (a) energy losses due to eddy currents may be minimised
(b) the weight of the transformer may be reduced
(c) rusting of the core may be prevented
(d) ratio of voltage in primary and secondary may be increased

Ans. (a)

When magnetic flux linked with a coil changes, induced emf is produced in it and the induced current flows through the wire forming the coil. In 1895, Foucault experimentally found that these induced currents are set up in the conductor in the form of closed loops. These currents look like eddies or whirlpools and likewise are known as eddy currents. They are also known as

Focault's current. These currents oppose the cause of their origin, therefore, due to eddy currents, a great amount of energy is wasted in form of heat energy. If core of transformer is laminated, then their effect can be minimised.

41 A step-up transformer operates on a 230 V line and supplies current of 2 A to a load. The ratio of the primary and secondary windings is 1 : 25. The current in the primary coil is

[CBSE AIPMT 1998]

- (a) 15 A (b) 50 A
(c) 25 A (d) 12.5 A

Ans. (b)

As change in flux of primary and secondary coil is proportional to the no. of turns in primary and secondary coil respectively.

So,
$$\frac{\phi_p}{N_p} = \frac{\phi_s}{N_s}$$

or
$$\frac{1}{N_p} \cdot \frac{d\phi_p}{dt} = \frac{1}{N_s} \frac{d\phi_s}{dt}$$

$$\therefore \frac{V_s}{V_p} = \frac{N_s}{N_p} \quad \left(\text{as } V \propto \frac{d\phi}{dt} \right)$$

For no loss of power,

$$Vi = \text{constant}$$

$$\therefore i = \frac{1}{V} \times \text{constant}$$

or
$$\frac{i_p}{i_s} = \frac{V_s}{V_p} \quad \text{or} \quad \frac{i_p}{i_s} = \frac{N_s}{N_p}$$

i_p and i_s are currents in primary and secondary coils

Here,
$$\frac{N_p}{N_s} = \frac{1}{25}$$

$$i_s = 2 \text{ A}$$

$$\therefore \frac{i_p}{2} = \frac{25}{1}$$

or
$$i_p = 25 \times 2 = 50 \text{ A}$$

42 The primary winding of transformer has 500 turns whereas its secondary has 5000 turns. The primary is connected to

an AC supply of 20V-50 Hz. The secondary will have an output of

[CBSE AIPMT 1997]

- (a) 2 V, 5 Hz (b) 200 V, 500 Hz
(c) 2 V, 50 Hz (d) 200 V, 50 Hz

Ans. (d)

The transformer converts AC high voltage into AC low voltage, but it does not cause any change in frequency.

The ratio of voltage across input with output

voltage is given by

$$\frac{V_s}{V_p} = \frac{N_s}{N_p}$$

N_s = No. of turns in secondary coil

N_p = No. of turns in primary coil

Making substitution, we obtain

$$V_s = \frac{N_s}{N_p} V_p$$

$$= \frac{5000}{500} \times 20 = 200 \text{ V}$$

Thus, output has voltage 200 V and frequency 50 Hz.