

**FINAL JEE-MAIN EXAMINATION – JULY, 2022**

(Held On Monday 25<sup>th</sup> July, 2022)

TIME : 3 : 00 PM to 6 : 00 PM

**PHYSICS**

**SECTION-A**

1. In AM modulation, a signal is modulated on a carrier wave such that maximum and minimum amplitude are found to be 6V and 2V respectively. The modulation index is

- (A) 100% (B) 80%  
(C) 60% (D) 50%

**Official Ans. by NTA (D)**

**Sol.** modulation index =  $\frac{V_{\max} - V_{\min}}{V_{\max} + V_{\min}} \times 100\%$

=  $\frac{6-2}{6+2} \times 100\% = 50\%$

2. The electric current in a circular coil of 2 turns produces a magnetic induction  $B_1$  at its centre. The coil is unwound and is rewound into a circular coil of 5 turns and the same current produces a magnetic induction  $B_2$  at its centre.

The ratio of  $\frac{B_2}{B_1}$  is :

(A)  $\frac{5}{2}$  (B)  $\frac{25}{4}$

(C)  $\frac{5}{4}$  (D)  $\frac{25}{2}$

**Official Ans. by NTA (B)**

**Sol.**  $B = \frac{N\mu_0 i}{2R}$

$B_1 = \frac{N_1\mu_0 i}{2R_1}$

For  $N_2 = 5$

Radius of coil =  $R_2 = \frac{N_1 \times R_1}{N_2}$

$B_2 = \frac{N_2\mu_0 i}{R_2}$

$\frac{B_2}{B_1} = \frac{N_2}{N_1} \frac{R_1}{R_2} = \frac{N_2}{N_1} \times \frac{N_2}{N_1}$ ;  $\frac{B_2}{B_1} = \frac{25}{4}$

**TEST PAPER WITH SOLUTION**

3. A drop of liquid of density  $\rho$  is floating half immersed in a liquid of density  $\sigma$  and surface tension  $7.5 \times 10^{-4} \text{ Ncm}^{-1}$ . The radius of drop in cm will be : (Take :  $g = 10 \text{ m/s}^2$ )

(A)  $\frac{15}{\sqrt{2\rho-\sigma}}$  (B)  $\frac{15}{\sqrt{\rho-\sigma}}$

(C)  $\frac{3}{2\sqrt{\rho-\sigma}}$  (D)  $\frac{3}{20\sqrt{2\rho-\sigma}}$

**Official Ans. by NTA (A)**

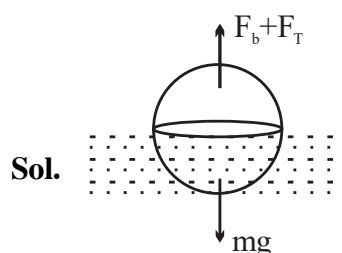

Boyant force + surace tension = mg

$\sigma \frac{V}{2} g + 2\pi R T = \rho V g$

$2\pi R T = \frac{(2\rho - \sigma)}{2} \cdot \frac{4}{3} \pi R^3 g$ ;  $\left[ V = \frac{4}{3} \pi R^3 \right]$

$R^3 = \frac{3T}{(2\rho - \sigma)g} \Rightarrow R = \sqrt{\frac{3 \times 7.5 \times 10^{-2} \text{ N} \cdot \text{m}^{-1}}{(2\rho - \sigma) \times 10}}$

$R = \frac{3}{20\sqrt{2\rho - \sigma}} \text{ m} = \frac{15}{\sqrt{2\rho - \sigma}} \text{ cm}$

4. Two billiard balls of mass 0.05 kg each moving in opposite directions with  $10 \text{ ms}^{-1}$  collide and rebound with the same speed. If the time duration of contact is  $t = 0.005 \text{ s}$ , then what is the force exerted on the ball due to each other?  
 (A) 100 N (B) 200 N  
 (C) 300 N (D) 400 N  
**Official Ans. by NTA (B)**

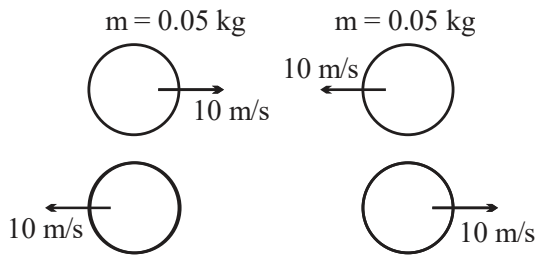

Sol.

Change in momentum of any one ball

$$|\Delta \vec{P}| = 2 \times 0.05 \times 10$$

$$|\Delta \vec{P}| = 1$$

$$|\vec{F}_{av}| = \frac{|\Delta \vec{P}|}{\Delta t}$$

$$F_{av} = 200 \text{ N}$$

5. For a free body diagram shown in the figure, the four forces are applied in the 'x' and 'y' directions. What additional force must be applied and at what angle with positive x-axis so that the net acceleration of body is zero?

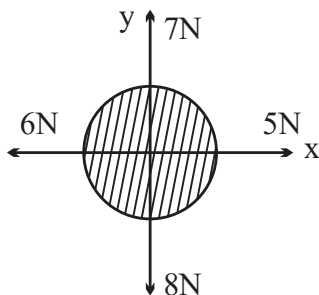

- (A)  $\sqrt{2} \text{ N}$ ,  $45^\circ$  (B)  $\sqrt{2} \text{ N}$ ,  $135^\circ$   
 (C)  $\frac{2}{\sqrt{3}} \text{ N}$ ,  $30^\circ$  (D)  $2 \text{ N}$ ,  $45^\circ$

**Official Ans. by NTA (A)**

Sol. Let addition force required is  $= \vec{F}$

$$\vec{F} + 5\hat{i} - 6\hat{i} + 7\hat{j} - 8\hat{j} = 0$$

$$\vec{F} = \hat{i} + \hat{j}, |\vec{F}| = \sqrt{2}$$

$$\text{Angle with x-axis: } \tan \theta = \frac{\text{y component}}{\text{x component}} = \frac{1}{1}$$

$$\theta = 45^\circ$$

6. Capacitance of an isolated conducting sphere of radius  $R_1$  becomes  $n$  times when it is enclosed by a concentric conducting sphere of radius  $R_2$  connected to earth. The ratio of their radii  $\left(\frac{R_2}{R_1}\right)$  is:

- (A)  $\frac{n}{n-1}$  (B)  $\frac{2n}{2n+1}$   
 (C)  $\frac{n+1}{n}$  (D)  $\frac{2n+1}{n}$

**Official Ans. by NTA (A)**

Sol. Capacitance of isolated Conducting sphere  
 $= 4\pi\epsilon_0 R_1$   
 By enclosing inside another sphere of radius

$$R_2, \text{ new capacitance} = \frac{4\pi\epsilon_0 R_1 R_2}{(R_2 - R_1)}$$

$$\text{Given: } \frac{4\pi\epsilon_0 R_1 R_2}{(R_2 - R_1)} = n \times 4\pi\epsilon_0 R_1$$

$$\Rightarrow \frac{R_2}{(R_2 - R_1)} = n \Rightarrow \frac{\frac{R_2}{R_1}}{\left(\frac{R_2}{R_1} - 1\right)} = n$$

$$\Rightarrow \frac{R_2}{R_1} = n \frac{R_2}{R_1} - n \Rightarrow \frac{R_2}{R_1} = \frac{n}{(n-1)}$$

7. The ratio of wavelengths of proton and deuteron accelerated by potential  $V_p$  and  $V_d$  is  $1:\sqrt{2}$ . Then, the ratio of  $V_p$  to  $V_d$  will be

- (A) 1 : 1                                      (B)  $\sqrt{2}$  : 1  
(C) 2 : 1                                      (D) 4 : 1

**Official Ans. by NTA (D)**

**Sol.** Kinetic energy gained by a charged particle accelerated by a potential  $V$  is  $qV$

$$KE = qV$$

$$\Rightarrow \frac{p^2}{2m} = qV \Rightarrow p = \sqrt{2mqV}$$

$$p = \frac{h}{\lambda}, \text{ thus } \lambda = \frac{h}{\sqrt{2mqV}}$$

$$\text{now } \frac{\lambda_p}{\lambda_d} = \sqrt{\frac{m_d V_d}{m_p V_p}}$$

$$\Rightarrow \frac{1}{\sqrt{2}} = \sqrt{\frac{2V_d}{V_p}} \Rightarrow \frac{V_p}{V_d} = 4$$

8. For an object placed at a distance 2.4 m from a lens, a sharp focused image is observed on a screen placed at a distance 12 cm from the lens. A glass plate of refractive index 1.5 and thickness 1 cm is introduced between lens and screen such that the glass plate plane faces parallel to the screen. By what distance should the object be shifted so that a sharp focused image is observed again on the screen?

- (A) 0.8 m                                      (B) 3.2 m  
(C) 1.2 m                                      (D) 5.6 m

**Official Ans. by NTA (B)**

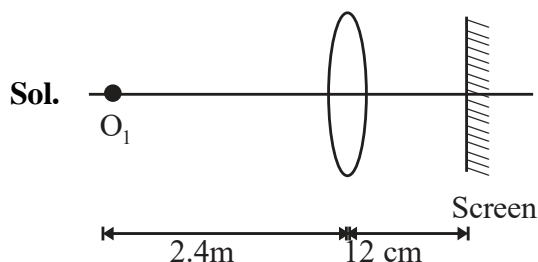

Applying lens formula

$$\frac{1}{0.12} + \frac{1}{2.4} = \frac{1}{f} \Rightarrow \frac{1}{f} = \frac{210}{24}$$

Upon putting the glass slab, shift of image is

$$\Delta x = t \left( 1 - \frac{1}{\mu} \right) = \frac{1}{3} \text{ cm}$$

$$\text{Now } v = 12 - \frac{1}{3} = \frac{35}{3} \text{ cm}$$

Again apply lens formula

$$\frac{1}{0.12} + \frac{1}{u} = \frac{1}{f} = \frac{210}{24}$$

$$\text{Solving } u = -5.6 \text{ m}$$

Thus shift of object is

$$5.6 - 2.4 = 3.2 \text{ m}$$

9. Light wave traveling in air along x-direction is given by  $E_y = 540 \sin \pi \times 10^4(x - ct)$   $\text{Vm}^{-1}$ . Then, the peak value of magnetic field of wave will be (Given  $c = 3 \times 10^8 \text{ ms}^{-1}$ )

- (A)  $18 \times 10^{-7} \text{ T}$                                       (B)  $54 \times 10^{-7} \text{ T}$   
(C)  $54 \times 10^{-8} \text{ T}$                                       (D)  $18 \times 10^{-8} \text{ T}$

**Official Ans. by NTA (A)**

**Sol.**  $E_y = 540 \sin \pi \times 10^4(x - ct) \text{ Vm}^{-1}$   
 $E_0 = 540 \text{ Vm}^{-1}$

$$B_0 = \frac{E_0}{c} = \frac{540}{3 \times 10^8} = 18 \times 10^{-7} \text{ T}$$

10. When you walk through a metal detector carrying a metal object in your pocket, it raises an alarm. This phenomenon works on  
(A) Electromagnetic induction  
(B) Resonance in ac circuits  
(C) Mutual induction in ac circuits  
(D) interference of electromagnetic waves

**Official Ans. by NTA (B)**

**Sol.** Metal detector works on the principle of transmitting an electromagnetic signal and analyses a return signal from the target. So it works on the principle of resonance in AC circuit.

11. An electron with energy 0.1 keV moves at right angle to the earth's magnetic field of  $1 \times 10^{-4} \text{ Wbm}^{-2}$ . The frequency of revolution of the electron will be  
(Take mass of electron =  $9.0 \times 10^{-31} \text{ kg}$ )  
(A)  $1.6 \times 10^5 \text{ Hz}$  (B)  $5.6 \times 10^5 \text{ Hz}$   
(C)  $2.8 \times 10^6 \text{ Hz}$  (D)  $1.8 \times 10^6 \text{ Hz}$   
**Official Ans. by NTA (C)**

Sol.  $f = \frac{1}{T} = \frac{eB}{2\pi m}$   
 $= \frac{1.6 \times 10^{-19} \times 10^{-4}}{2\pi \times 9 \times 10^{-31}} = 2.8 \times 10^6 \text{ Hz}$

12. A current of 15 mA flows in the circuit as shown in figure. The value of potential difference between the points A and B will be

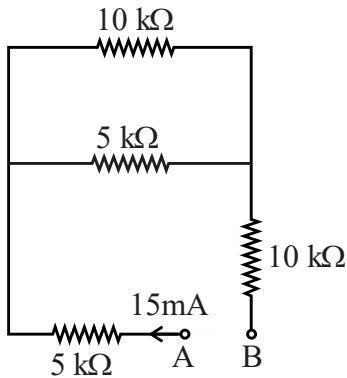

- (A) 50V (B) 75V  
(C) 150V (D) 275V  
**Official Ans. by NTA (D)**

Sol.

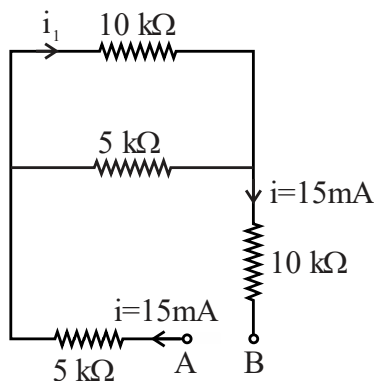

$i_1 = \frac{5}{10+5} \times 15 \text{ mA} = 5 \text{ mA}$   
 $V_A - 5i - 10i_1 - 10i = V_B$   
 $V_A - V_B = 75 + 50 + 150 = 275 \text{ V}$

13. The length of a seconds pendulum at a height  $h = 2R$  from earth surface will be:  
(Given:  $R = \text{Radius of earth}$  and acceleration due to gravity at the surface of earth  $g = \pi^2 \text{ m/s}^{-2}$ )  
(A)  $\frac{2}{9} \text{ m}$  (B)  $\frac{4}{9} \text{ m}$   
(C)  $\frac{8}{9} \text{ m}$  (D)  $\frac{1}{9} \text{ m}$   
**Official Ans. by NTA (D)**

Sol.  $T = 2\pi \sqrt{\frac{L}{g}}$ ,  $g' = \frac{GM}{9R^2} = \frac{g}{9} = \frac{\pi^2}{9}$   
 $2 = 2\pi \sqrt{\frac{L}{\pi^2} \times 9}$   
 $\Rightarrow 1 = \pi \sqrt{L} \times \frac{3}{\pi} \Rightarrow L = \frac{1}{9} \text{ m}$

14. Sound travels in a mixture of two moles of helium and  $n$  moles of hydrogen. If rms speed of gas molecules in the mixture is  $\sqrt{2}$  times the speed of sound, then the value of  $n$  will be  
(A) 1 (B) 2  
(C) 3 (D) 4  
**Official Ans. by NTA (B)**

Sol.  $v_s = \sqrt{\frac{\gamma RT}{M}}$   
 $v_{\text{rms}} = \sqrt{\frac{3RT}{M}}$   
 $\frac{v_s}{v_{\text{rms}}} = \sqrt{\frac{\gamma}{3}} = \frac{1}{\sqrt{2}} \Rightarrow \frac{\gamma}{3} = \frac{1}{2} \Rightarrow \gamma = \frac{3}{2}$   
 $\gamma = 1 + \frac{2}{f_{\text{mix.}}}$   
 $f_{\text{mix.}} = \frac{2 \times 3 + n \times 5}{n + 2} = \frac{6 + n \times 5}{n + 2}$   
 $\gamma = 1 + \frac{2(n+2)}{6 + n \times 5} = \frac{6 + 5n + 2n + 4}{6 + 5n}$   
 $\gamma = \frac{7n + 10}{6 + 5n} = \frac{3}{2}$   
 $14n + 20 = 18 + 15n$   
 $n = 2$

15. Let  $\eta_1$  is the efficiency of an engine at  $T_1 = 447^\circ\text{C}$  and  $T_2 = 147^\circ\text{C}$  while  $\eta_2$  is the efficiency at  $T_1 = 947^\circ\text{C}$  and  $T_2 = 47^\circ\text{C}$ . The

ratio  $\frac{\eta_1}{\eta_2}$  will be :

- (A) 0.41 (B) 0.56  
(C) 0.73 (D) 0.70

**Official Ans. by NTA (B)**

**Sol.** Efficiency  $\eta = 1 - \frac{T_L}{T_H}$

$$\eta_1 = 1 - \frac{147 + 273}{447 + 273} = 1 - \frac{420}{720}$$

$$\eta_1 = \frac{300}{720}$$

$$\eta_2 = 1 - \frac{47 + 273}{947 + 273} = 1 - \frac{320}{1220}$$

$$\eta_2 = \frac{900}{1220}$$

$$\frac{\eta_1}{\eta_2} = \frac{300}{720} \times \frac{1220}{900} = \frac{122}{72 \times 3}$$

$$\frac{\eta_1}{\eta_2} = 0.56$$

16. An object is taken to a height above the surface of earth at a distance  $\frac{5}{4}R$  from the centre of the earth. Where radius of earth,  $R = 6400$  km. The percentage decrease in the weight of the object will be

- (A) 36% (B) 50%  
(C) 64% (D) 25%

**Official Ans. by NTA (A)**

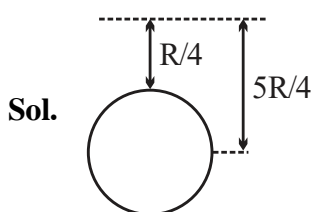

$$g_{\text{eff}} = \frac{g}{\left(1 + \frac{h}{R}\right)^2}; \quad g_{\text{eff}} = \frac{g}{\left(1 + \frac{1}{4}\right)^2} = \frac{16g}{25}$$

$$\begin{aligned} \text{change} &= \frac{g_{\text{eff}} - g}{g} \times 100 = \frac{\frac{16}{25}g - g}{g} \times 100 \\ &= \frac{-9}{25} \times 100 = -36\% \end{aligned}$$

Hence % decrease in the weight = 36%

17. A bag of sand of mass 9.8 kg is suspended by a rope. A bullet of 200 g travelling with speed  $10 \text{ ms}^{-1}$  gets embedded in it, then loss of kinetic energy will be

- (A) 4.9 J (B) 9.8 J  
(C) 14.7 (D) 19.6 J

**Official Ans. by NTA (B)**

**Sol.**  $P_i = P_f$  (no any external force)

$$0.2 \times 10 = 10 \times v$$

$$v = 0.2 \text{ m/sec}$$

$$\text{Loss in K.E.} = \frac{1}{2} \times (0.2) \times 10^2 - \frac{1}{2} \times 10 \times (0.2)^2$$

$$= \frac{1}{2} \times 10 \times (0.2) [10 - 0.2]$$

$$= 9.8 \text{ J}$$

18. A ball is projected from the ground with a speed  $15 \text{ ms}^{-1}$  at an angle  $\theta$  with horizontal so that its range and maximum height are equal, then ' $\tan \theta$ ' will be equal to

- (A)  $\frac{1}{4}$  (B)  $\frac{1}{2}$   
(C) 2 (D) 4

**Official Ans. by NTA (D)**

**Sol.**  $R = H$

$$\frac{2v_x \times v_y}{g} = \frac{v_y^2}{2g}$$

$$v_x = \frac{v_y}{4}; \quad u \cos \theta = \frac{u \sin \theta}{4}$$

$$\tan \theta = 4$$

19. The maximum error in the measurement of resistance, current and time for which current flows in an electrical circuit are 1%, 2% and 3% respectively. The maximum percentage error in the detection of the dissipated heat will be:

- (A) 2 (B) 4  
(C) 6 (D) 8

Official Ans. by NTA (D)

Sol.  $E_H = I^2 R \times t$

$$\frac{\Delta E}{E} \times 100 = \frac{2\Delta I}{I} \times 100 + \frac{\Delta R}{R} \times 100 + \frac{\Delta T}{T} \times 100$$

$$= 2 \times 2 + 1 + 3 = 8$$

20. Hydrogen atom from excited state comes to the ground by emitting a photon of wavelength  $\lambda$ . The value of principal quantum number 'n' of the excited state will be :

(R : Rydberg constant)

- (A)  $\sqrt{\frac{\lambda R}{\lambda - 1}}$  (B)  $\sqrt{\frac{\lambda R}{\lambda R - 1}}$   
(C)  $\sqrt{\frac{\lambda}{\lambda R - 1}}$  (D)  $\sqrt{\frac{\lambda R^2}{\lambda R - 1}}$

Official Ans. by NTA (B)

Sol.

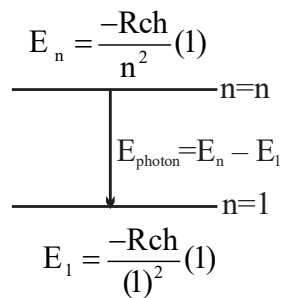

$$E_n = \frac{-Rch}{n^2} (1)$$

$$E_1 = \frac{-Rch}{(1)^2} (1)$$

$$\frac{-Rch}{(n)^2} + \frac{Rch}{1} = \frac{hc}{\lambda}$$

$$\frac{-R}{n^2} + R = \frac{1}{\lambda}$$

$$R - \frac{1}{\lambda} = \frac{R}{n^2}$$

$$\frac{\lambda R - 1}{\lambda} = \frac{R}{n^2}$$

$$n^2 = \frac{\lambda R}{\lambda R - 1} \Rightarrow n = \sqrt{\frac{\lambda R}{\lambda R - 1}}$$

**SECTION-B**

1. A particle is moving in a straight line such that its velocity is increasing at  $5 \text{ ms}^{-1}$  per meter. The acceleration of the particle is \_\_\_\_\_  $\text{ms}^{-2}$  at a point where its velocity is  $20 \text{ ms}^{-1}$ .

Official Ans. by NTA (100)

Sol.  $\frac{dv}{ds} = 5$

$$a = v \frac{dv}{ds} = 20 \times 5 = 100 \text{ m/sec}^2$$

2. Three identical spheres each of mass M are placed at the corners of a right angled triangle with mutually perpendicular sides equal to 3 m each. Taking point of intersection of mutually perpendicular sides as origin, the magnitude of position vector of centre of mass of the system will be  $\sqrt{x} \text{ m}$ . The value of x is

Official Ans. by NTA (2)

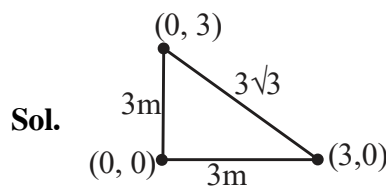

$$\vec{r}_{\text{com}} = \frac{M(0\hat{i} + 0\hat{j}) + M(3\hat{i}) + M(3\hat{j})}{3M}$$

$$\vec{r}_{\text{com}} = \hat{i} + \hat{j}$$

$$|\vec{r}_{\text{com}}| = \sqrt{2} = \sqrt{x}$$

$$x = 2$$

3. A block of ice of mass 120 g at temperature  $0^{\circ}\text{C}$  is put in 300 gm of water at  $25^{\circ}\text{C}$ . The  $x\text{g}$  of ice melts as the temperature of the water reaches  $0^{\circ}\text{C}$ . The value of  $x$  is

[Use: Specific heat capacity of water =  $4200 \text{ Jkg}^{-1}\text{K}^{-1}$ , Latent heat of ice =  $3.5 \times 10^5 \text{ Jkg}^{-1}$ ]

**Official Ans. by NTA (90)**

**Sol.** Energy released by water  
 $= 0.3 \times 25 \times 4200 = 31500 \text{ J}$   
 let  $m \text{ kg}$  ice melts  
 $m \times 3.5 \times 10^5 = 31500$

$$m = \frac{31500 \times 10^{-5}}{3.5} = 9000 \times 10^{-5}$$

$$m = 0.09 \text{ kg} = 90 \text{ gm}$$

$$x = 90$$

4.  $\frac{x}{x+4}$  is the ratio of energies of photons produced due to transition of an electron of hydrogen atom from its

(i) third permitted energy level to the second level and

(ii) the highest permitted energy level to the second permitted level.

The value of  $x$  will be

**Official Ans. by NTA (5)**

**Sol.** 
$$\frac{13.6 \left( \frac{1}{2^2} - \frac{1}{3^2} \right)}{13.6 \left( \frac{1}{2^2} - 0 \right)} = \frac{x}{x+4}; \quad \frac{1}{4} - \frac{1}{9} = \frac{x}{x+4}$$

$$\frac{5}{9} = \frac{x}{x+4}$$

$$5x + 20 = 9x$$

$$4x = 20$$

$$x = 5$$

5. In a potentiometer arrangement, a cell of emf 1.20 V gives a balance point at 36 cm length of wire. This cell is now replaced by another cell of emf 1.80 V. The difference in balancing length of potentiometer wire in above conditions will be \_\_\_\_\_ cm.

**Official Ans. by NTA (18)**

**Sol.**  $1.2 = (\text{Potential Gradient}) \times 36$   
 $1.8 = (\text{Potential Gradient}) \times x$   
 On dividing, we get

$$\frac{2}{3} = \frac{36}{x}$$

$$x = 18 \times 3 = 54 \text{ cm}$$

$$\text{Hence difference} = 54 - 36 = 18 \text{ cm}$$

6. Two ideal diodes are connected in the network as shown in figure. The equivalent resistance between A and B is \_\_\_\_\_  $\Omega$ .

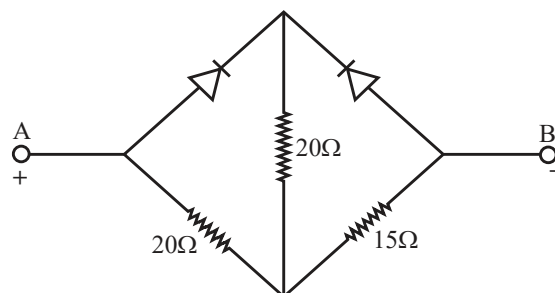

**Official Ans. by NTA (25)**

**Sol.**

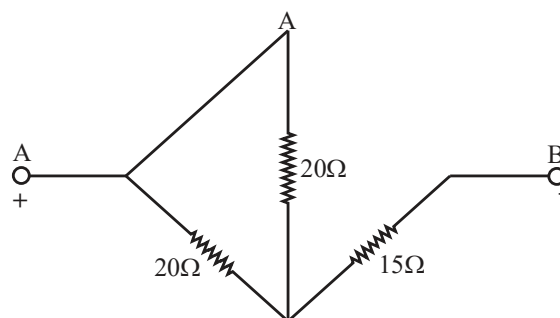

The forward biased diode will conduct while the reverse biased will not

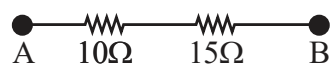

$$\therefore \text{Equivalent resistance} = 10 + 15 = 25\Omega$$

7. Two waves executing simple harmonic motion travelling in the same direction with same amplitude and frequency are superimposed. The resultant amplitude is equal to the  $\sqrt{3}$  times of amplitude of individual motions. The phase difference between the two motions is \_\_\_\_\_ (degree)

**Official Ans. by NTA (60)**

**Sol.**  $A_{\text{resultant}} = \sqrt{A_1^2 + A_2^2 + 2A_1A_2 \cos \phi}$

$$\Rightarrow \sqrt{3}A = \sqrt{A^2 + A^2 + 2A^2 \cos \phi}$$

$$\Rightarrow 3A^2 = 2A^2 + 2A^2 \cos \phi$$

$$\Rightarrow \cos \phi = \frac{1}{2}$$

$$\therefore \phi = 60^\circ$$

$\therefore$  Phase difference = 60 degree

8. Two parallel plate capacitors of capacity C and 3C are connected in parallel combination and charged to a potential difference 18V. The battery is then disconnected and the space between the plates of the capacitor of capacity C is completely filled with a material of dielectric constant 9. The final potential difference across the combination of capacitors will be \_\_\_\_\_ V

**Official Ans. by NTA (6)**

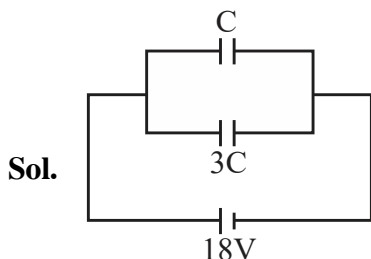

Initial charge on C = 18 CV

initial charge on 3C = 54 CV

Let final common potential difference = V'

$$9CV' + 3CV' = 18CV + 54CV$$

$$\Rightarrow 12CV' = 72 CV \Rightarrow V' = 6 V$$

9. A convex lens of focal length 20 cm is placed in front of convex mirror with principal axis coinciding each other. The distance between the lens and mirror is 10 cm. A point object is placed on principal axis at a distance of 60 cm from the convex lens. The image formed by combination coincides the object itself. The focal length of the convex mirror is \_\_\_\_\_ cm.  
**Official Ans. by NTA (10)**

**Sol.**

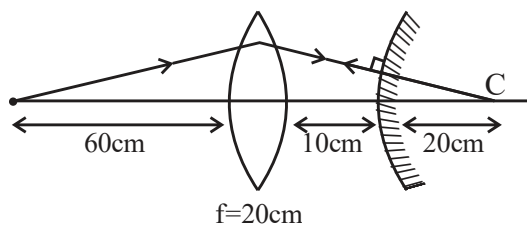

For lens

$$\frac{1}{v} - \frac{1}{u} = \frac{1}{f}$$

$$\Rightarrow \frac{1}{v} - \frac{1}{(-60)} = \frac{1}{20} \Rightarrow \frac{1}{v} + \frac{1}{60} = \frac{1}{20}$$

$$v = 30 \text{ cm}$$

For final image to be formed on the object itself, after refraction from lens the ray should meet the mirror perpendicularly and the image by lens should be on the centre of curvature of mirror

$$R = 30 - 10 = 20 \text{ cm}$$

$$\text{Focal length of mirror} = R/2 = 10 \text{ cm}$$

10. Magnetic flux (in weber) in a closed circuit of resistance  $20 \Omega$  varies with time t(s) as  $\phi = 8t^2 - 9t + 5$ . The magnitude of the induced current at  $t = 0.25 \text{ s}$  will be \_\_\_\_\_ mA

**Official Ans. by NTA (250)**

**Sol.**  $\phi = 8t^2 - 9t + 5$

$$\text{emf} = -\frac{d\phi}{dt} = -(16t - 9)$$

At  $t = 0.25 \text{ s}$

$$\text{Emf} = -[(16 \times 0.25) - 9] = 5V$$

$$\text{Current} = \frac{\text{Emf}}{\text{Resistance}} = \frac{5V}{20\Omega}$$

$$= \frac{1}{4} \text{ A} = \frac{1000}{4} \text{ mA} = 250 \text{ mA}$$



**FINAL JEE-MAIN EXAMINATION – JULY, 2022**

(Held On Monday 25<sup>th</sup> July, 2022)

TIME : 3 : 00 PM to 06 : 00 PM

**CHEMISTRY**

**SECTION-A**

1. Match List I with List II :

List-I (molecule)	List-II (hybridization; shape)
A. XeO <sub>3</sub>	I. sp <sup>3</sup> d ; linear
B. XeF <sub>2</sub>	II. sp <sup>3</sup> ; pyramidal
C. XeOF <sub>4</sub>	III. sp <sup>3</sup> d <sup>2</sup> ; distorted octahedral
D. XeF <sub>6</sub>	IV. sp <sup>3</sup> d <sup>2</sup> ; square pyramidal

Choose the correct answer from the options given below:

- (A) A-II, B-I, C-IV, D-III  
 (B) A-II, B-IV, C-III, D-I  
 (C) A-IV, B-II, C-III, D-I  
 (D) A-IV, B-II, C-I, D-III

Official Ans. by NTA (A)

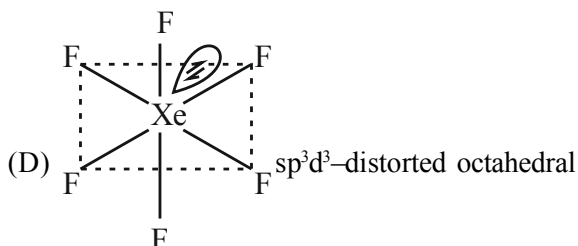
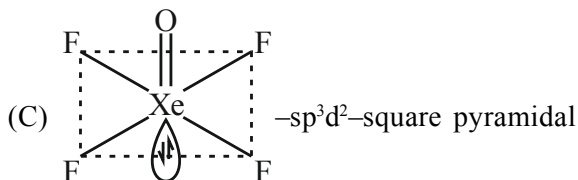
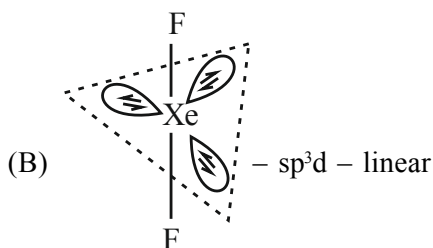
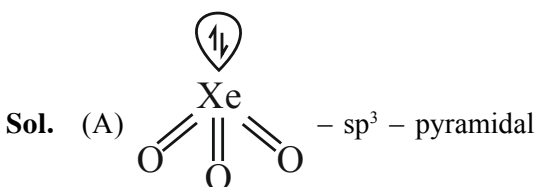

**TEST PAPER WITH SOLUTION**

2. Two solutions A and B are prepared by dissolving 1 g of non-volatile solutes X and Y, respectively in 1 kg of water. The ratio of depression in freezing points for A and B is found to be 1 : 4. The ratio of molar masses of X and Y is :

- (A) 1 : 4  
 (B) 1 : 0.25  
 (C) 1 : 0.20  
 (D) 1 : 5

Official Ans. by NTA (B)

Sol. 
$$\frac{\Delta T_{fx}}{\Delta T_{fy}} = \frac{k_f \cdot m_x}{k_f \cdot m_y} = \frac{\frac{1}{M_x}}{\frac{1}{M_y}}$$

$$\Rightarrow \frac{1}{4} = \frac{M_y}{M_x}$$

$$\Rightarrow M_x : M_y = 1 : 0.25$$

3. K<sub>a1</sub>, K<sub>a2</sub> and K<sub>a3</sub> are the respective ionization constants for the following reactions (a),(b), and (c).

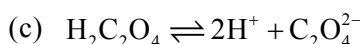
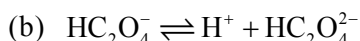
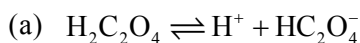

The relationship between K<sub>a1</sub>, K<sub>a2</sub> and K<sub>a3</sub> is given as



Official Ans. by NTA (D)

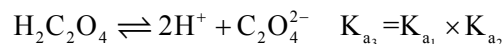
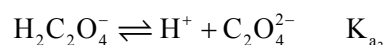
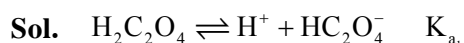

4. The molar conductivity of a conductivity cell filled with 10 moles of 20 mL NaCl solution is  $\Lambda_{m1}$  and that of 20 moles another identical cell heaving 80 mL NaCl solution is  $\Lambda_{m2}$ , The conductivities exhibited by these two cells are same.

The relationship between  $\Lambda_{m2}$  and  $\Lambda_{m1}$  is

- (A)  $\Lambda_{m2} = 2\Lambda_{m1}$       (B)  $\Lambda_{m2} = \Lambda_{m1} / 2$   
 (C)  $\Lambda_{m2} = \Lambda_{m1}$       (D)  $\Lambda_{m2} = 4\Lambda_{m1}$

**Official Ans. by NTA (A)**

**Sol.**  $\Lambda_m = \kappa \times \frac{1000}{M}$

$\Rightarrow \Lambda_m \propto \frac{1}{M}$

$\frac{\Lambda_{m1}}{\Lambda_{m2}} = \frac{M_2}{M_1} = \frac{80}{10} = \frac{1}{4} \times \frac{2}{1} = \frac{1}{2}$

$\Rightarrow \Lambda_{m2} = 2\Lambda_{m1}$

5. For micelle formation, which of the following statements are correct?

- (A) Micelle formation is an exothermic process.  
 (B) Micelle formation is an endothermic process.  
 (C) The entropy change is positive.  
 (D) The entropy change is negative.  
 (A) A and D only      (B) A and C only  
 (C) B and C only      (D) B and D only

**Official Ans. by NTA (A)**

- Sol.** For micelle formation,  $\Delta S > 0$  (hydrophobic effect) This is possible because, the decrease in entropy due to clustering is offset by increase in entropy due to desolvation of the surfactant, Also  $\Delta H > 0$

6. The first ionization enthalpies of Be, B, N and O follow the order

- (A)  $O < N < B < Be$       (B)  $Be < B < N < O$   
 (C)  $B < Be < N < O$       (D)  $B < Be < O < N$

**Official Ans. by NTA (D)**

**Sol.** 1<sup>st</sup> I.E.  $\frac{N}{(2p^3)} > \frac{O}{(2p^4)} > \frac{Be}{(2s^2)} > \frac{B}{(2p^1)}$

7. Given below are two statements.

**Statement I:** Pig iron is obtained by heating cast iron with scrap iron.

**Statement II:** Pig iron has a relatively lower carbon content than that of cast iron. In the light of the above statements, choose the correct answer from the options given below.

- (A) Both Statement I and Statement II are correct.  
 (B) Both Statement I and Statement II are not correct.  
 (C) Statement I is correct but Statement II is not correct  
 (D) Statement I is not correct but Statement II is correct.

**Official Ans. by NTA (B)**

- Sol.** Statement –I is incorrect because cast iron is obtained by heating pig iron with scrap iron Statement–II is also incorrect because pig iron has more carbon content (~4%) than cast iron (~3%)

8. High purity (>99.95%) dihydrogen is obtained by  
 (A) reaction of zinc with aqueous alkali.  
 (B) electrolysis of acidified water using platinum electrodes.  
 (C) electrolysis of warm aqueous barium hydroxide solution between nickel electrodes.  
 (D) reaction of zinc with dilute acid.

**Official Ans. by NTA (C)**

- Sol.** High purity (>99.95%) dihydrogen is obtained by electrolysis of warm aqueous  $Ba(OH)_2$  solution between Ni-electrodes

9. The correct order of density is

- (A)  $Be > Mg > Ca > Sr$   
 (B)  $Sr > Ca > Mg > Be$   
 (C)  $Sr > Be > Mg > Ca$   
 (D)  $Be > Sr > Mg > Ca$

**Official Ans. by NTA (C)**

- Sol.** In II'A' group density decreases down the group till Ca and after that it increases.

Correct order of density is  
 $Sr > Be > Mg > Ca$

- 10.** The total number of acidic oxides from the following list is: NO, N<sub>2</sub>O, B<sub>2</sub>O<sub>3</sub>, N<sub>2</sub>O<sub>5</sub>, CO, SO<sub>3</sub>, P<sub>4</sub>O<sub>10</sub>
- (A) 3 (B) 4  
(C) 5 (D) 6

**Official Ans. by NTA (B)**

**Sol.** Neutral Oxides — N<sub>2</sub>O, NO, CO  
Acidic Oxides — B<sub>2</sub>O<sub>3</sub>, N<sub>2</sub>O<sub>5</sub>, SO<sub>3</sub>, P<sub>4</sub>O<sub>10</sub>

- 11.** The correct order of energy of absorption for the following metal complexes is  
A: [Ni(en)<sub>3</sub>]<sup>2+</sup>, B: [Ni(NH<sub>3</sub>)<sub>6</sub>]<sup>2+</sup>, C: [Ni(H<sub>2</sub>O)<sub>6</sub>]<sup>2+</sup>
- (A) C < B < A  
(B) B < C < A  
(C) C < A < B  
(D) A < C < B

**Official Ans. by NTA (A)**

**Sol.** Stronger the ligand, larger the splitting & higher the energy of absorption.

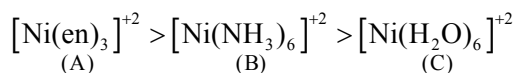

- 12. Match List I with List II.**

List-I		List-II	
A.	Sulphate	I.	Pesticide
B.	Fluoride	II.	Bending of bones
C.	Nicotine	III.	Laxative effect
D.	Sodium arsinite	IV.	Herbicide

Choose the correct answer from the options given below:

- (A) A-II, B-III, C-IV, D-I  
(B) A-IV, B-III, C-II, D-I  
(C) A-III, B-II, C-I, D-IV  
(D) A-III, B-II, C-IV, D-I

**Official Ans. by NTA (C)**

**Sol.** A-Sulphate – III (Laxative effect)  
B-Fluoride – II (Bending of bones)  
C-Nicotine – I (pesticides)  
D-Sodium Arsinite – IV (herbicide)

- 13.** Major product of the following reaction is

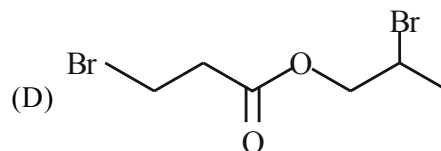
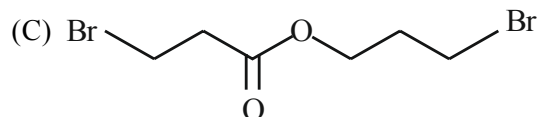
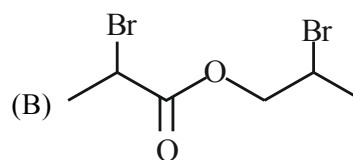
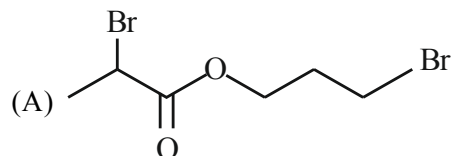
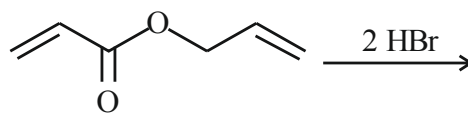

**Official Ans. by NTA (D)**

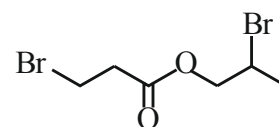
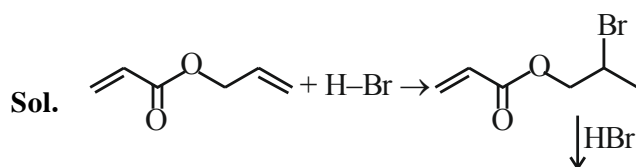

14. What is the major product of the following reaction?

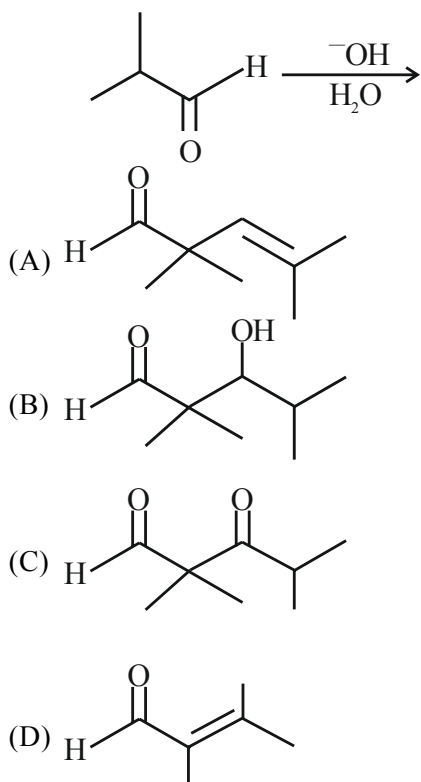

Official Ans. by NTA (B)

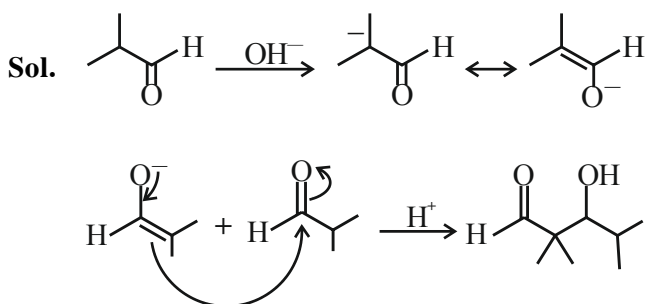

Aldol formation takes place.

15. Arrange the following in decreasing acidic strength.

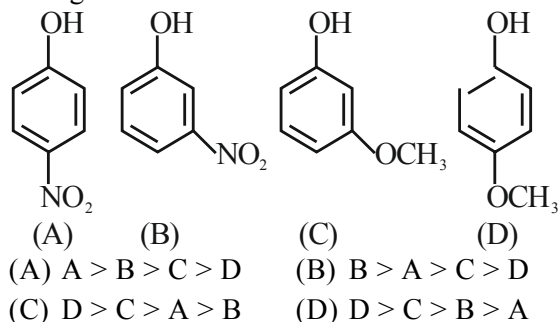

Official Ans. by NTA (A)

Sol. The correct order of acid strength is

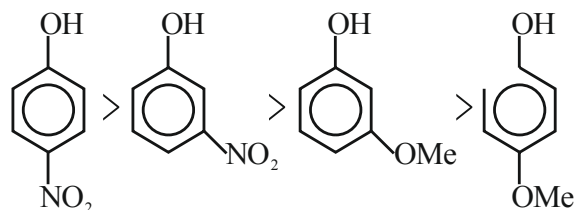

16.  $\text{CH}_3-\text{CH}_2-\text{CN} \xrightarrow[\text{Ether}]{\text{CH}_3\text{MgBr}} \text{A} \xrightarrow{\text{H}_3\text{O}^+} \text{B} \xrightarrow[\text{HCl}]{\text{Zn-Hg}} \text{C}$

The correct structure of C is

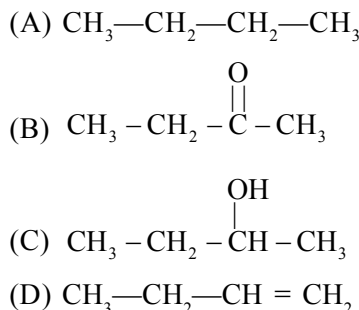

Official Ans. by NTA (A)

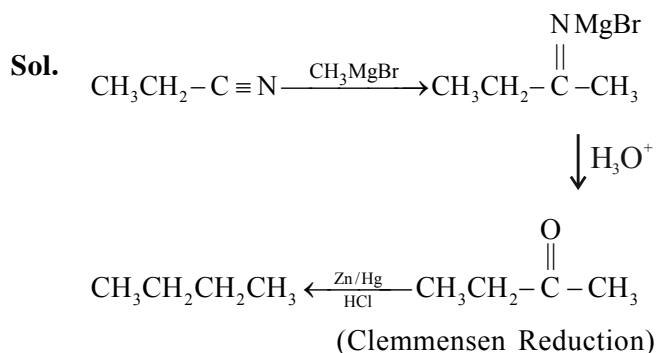

17. Match List I with List II :

List-I Polymer	List-II used for items
A. Nylon 6,6	I. Buckets
B. Low density polythene	II. Non-stick utensils
C. High density polythene	III. Bristles of brushes
D. Teflon	IV. Toys

Choose the correct answer from the options given below:

- (A) A-III, B-I, C-IV, D-II  
 (B) A-III, B-IV, C-I, D-II  
 (C) A-II, B-I, C-IV, D-III  
 (D) A-II, B-IV, C-I, D-III

Official Ans. by NTA (B)

Sol. LDPE  $\rightarrow$  Toys  
 HDPE  $\rightarrow$  Buckets (As per NCERT)

18. Glycosidic linkage between C<sub>1</sub> of α-glucose and C<sub>2</sub> of β-fructose is found in  
 (A) maltose (B) sucrose  
 (C) lactose (D) amylose

**Official Ans. by NTA (B)**

**Sol. Theoretical**

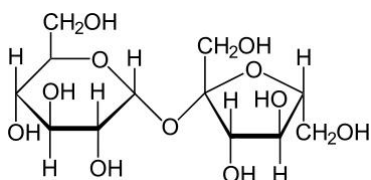

19. Some drugs bind to a site other than, the active site of an enzyme. This site is known as  
 (A) non-active site (B) allosteric site  
 (C) competitive site (D) therapeutic site

**Official Ans. by NTA (B)**

**Sol. Theoretical**

20. In base vs. Acid titration, at the end point methyl orange is present as  
 (A) quinonoid form (B) heterocyclic form  
 (C) phenolic form (D) benzenoid form

**Official Ans. by NTA (A)**

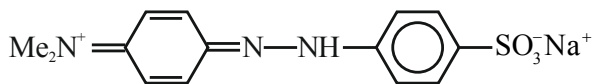
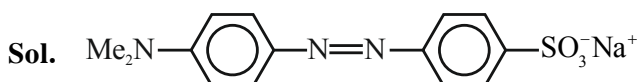

**(QUINONOID FORM)**

**SECTION-B**

1. 56.0 L of nitrogen gas is mixed with excess of hydrogen gas and it is found that 20 L of ammonia gas is produced. The volume of unused nitrogen gas is found to be \_\_\_\_ L.

**Official Ans. by NTA (46)**

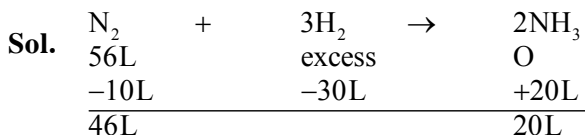

2. A sealed flask with a capacity of 2 dm<sup>3</sup> contains 11 g of propane gas. The flask is so weak that it will burst if the pressure becomes 2 MPa. The minimum temperature at which the flask will burst is \_\_\_\_ °C. [Nearest integer]  
 (Given: R = 8.3 J K<sup>-1</sup> mol<sup>-1</sup>. Atomic masses of C and H are 12u and 1u respectively.) (Assume that propane behaves as an ideal gas.)

**Official Ans. by NTA (1655)**

Sol. Moles of C<sub>3</sub>H<sub>8</sub> =  $\frac{11}{44} = 0.25$  moles

PV = nRT

⇒ 2 × 10<sup>6</sup> × 2 × 10<sup>-3</sup> = 0.25 × 8.3 × T

⇒ T = 1927.710 K = 1654.56°C

3. When the excited electron of a H atom from n = 5 drops to the ground state, the maximum number of emission lines observed are \_\_\_\_

**Official Ans. by NTA (10)**

- Sol. Since only a single H atom is present, maximum number of spectral lines = 4

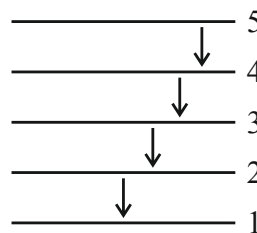

4. While performing a thermodynamics experiment, a student made the following observations,  
 HCl + NaOH → NaCl + H<sub>2</sub>O ΔH = -57.3 kJ mol<sup>-1</sup>  
 CH<sub>3</sub>COOH + NaOH → CH<sub>3</sub>COONa + H<sub>2</sub>O  
 ΔH = -55.3 kJ mol<sup>-1</sup>.  
 The enthalpy of ionization of CH<sub>3</sub>COOH as calculated by the student is \_\_\_\_ kJ mol<sup>-1</sup>. (nearest integer)

**Official Ans. by NTA (2)**

Sol. ΔH<sub>ionisation</sub> of CH<sub>3</sub>COOH = |-57.3 - (-55.3)|  
 = 2 KJ/mol

5. For the decomposition of azomethane.  
 $\text{CH}_3\text{N}_2\text{CH}_3(\text{g}) \rightarrow \text{CH}_3\text{CH}_3(\text{g}) + \text{N}_2(\text{g})$  a first order reaction, the variation in partial pressure with time at 600 K is given as

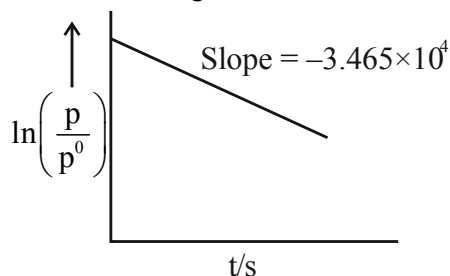

The half life of the reaction is \_\_\_\_\_  $\times 10^{-5}$ s.  
 [Nearest integer]

**Official Ans. by NTA (2)**

**Sol.** For first order reaction

$$k = \frac{1}{t} \ln \left( \frac{P_0}{P} \right)$$

$$\ln \left( \frac{P_0}{P} \right) = kt$$

$$t_{1/2} = \frac{\ln 2}{k} = \frac{0.693}{3.465 \times 10^4} = 2 \times 10^{-5}$$

6. The sum of number of lone pairs of electrons present on the central atoms of  $\text{XeO}_3$ ,  $\text{XeOF}_4$  and  $\text{XeF}_6$  is \_\_\_\_\_

**Official Ans. by NTA (3)**

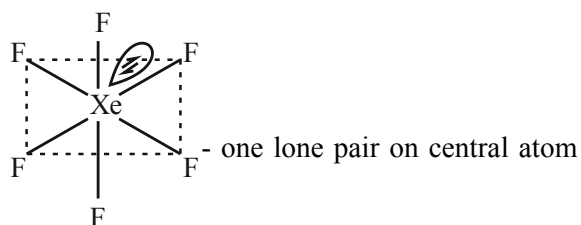
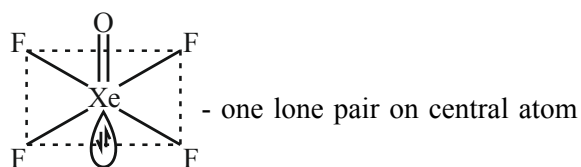
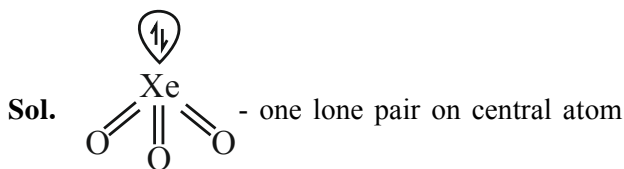

7. The spin-only magnetic moment value of  $\text{M}^{3+}$  ion (in gaseous state) from the pairs  $\text{Cr}^{3+}/\text{Cr}^{2+}$ ,  $\text{Mn}^{3+}/\text{Mn}^{2+}$ ,  $\text{Fe}^{3+}/\text{Fe}^{2+}$  and  $\text{Co}^{3+}/\text{Co}^{2+}$  that has negative standard electrode potential, is B.M.

[Nearest integer]

**Official Ans. by NTA (4)**

**Sol.**  $E_{\text{Cr}^{3+}}^0 |_{\text{Cr}^{2+}} = -0.41\text{V}$

$$[\text{Cr}^{+3}] = 4s^0 3d^3$$

$$\mu = \sqrt{n(n+2)} \text{ B.M}$$

$$= \sqrt{15} \text{ B.M} \sim 4 \text{ B.M}$$

8. A sample of 4.5 mg of an unknown monohydric alcohol,  $\text{R-OH}$  was added to methylmagnesium iodide. A gas is evolved and is collected and its volume measured to be 3.1 mL. The molecular weight of the unknown alcohol is \_\_\_\_\_ g/mol.  
 [Nearest integer]

**Official Ans. by NTA (33)**



moles of  $\text{CH}_4$  = moles of  $\text{ROH}$

$$\Rightarrow \frac{V}{22400} = \frac{m}{\text{M.M}} \quad (\text{Assuming NTP Condition})$$

$$\Rightarrow \frac{3.1}{22400} = \frac{4.5 \times 10^{-3}}{\text{M.M}}$$

$$\Rightarrow \text{M.M} = 32.51$$

Nearest Integer = 33

9. The separation of two coloured substances was done by paper chromatography. The distances travelled by solvent front, substance A and substance B from the base line are 3.25 cm, 2.08 cm and 1.05 cm, respectively. The ratio of  $R_f$  values of A to B is \_\_\_\_\_

Official Ans. by NTA (2)

Sol. 
$$\frac{R_{fA}}{R_{fB}} = \frac{\frac{2.08}{3.25}}{\frac{1.05}{3.25}} = \frac{2.08}{1.05} \approx 2$$

10. The total number of monobromo derivatives formed by the alkanes with molecular formula  $C_5H_{12}$  is (excluding stereo isomers) \_\_\_\_\_

Official Ans. by NTA (8)

Sol. The Alkanes and their monobromoderivative are

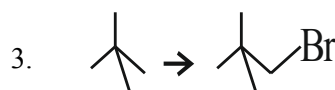
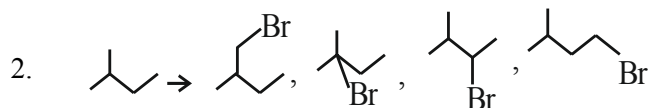
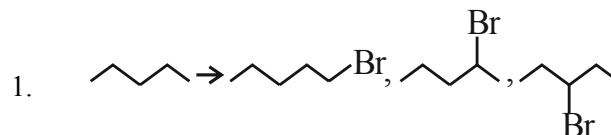

**FINAL JEE-MAIN EXAMINATION – JULY, 2022**

(Held On Monday 25<sup>th</sup> July, 2022)

TIME : 3 : 00 PM to 6 : 00 PM

**MATHEMATICS**

**TEST PAPER WITH ANSWER**

**SECTION-A**

1. For  $z \in \mathbb{C}$  if the minimum value of  $(|z - 3\sqrt{2}| + |z - p\sqrt{2}i|)$  is  $5\sqrt{2}$ , then a value of p is \_\_\_\_\_

- (A) 3 (B)  $\frac{7}{2}$   
(C) 4 (D)  $\frac{9}{2}$

Official Ans. by NTA (C)

2. The number of real values  $\lambda$ , such that the system of linear equations

$$2x - 3y + 5z = 9$$

$$x + 3y - z = -18$$

$$3x - y + (\lambda^2 - |\lambda|)z = 16$$

has no solution, is :-

- (A) 0 (B) 1  
(C) 2 (D) 4

Official Ans. by NTA (C)

3. The number of bijective functions  $f : \{1, 3, 5, 7, \dots, 99\} \rightarrow \{2, 4, 6, 8, \dots, 100\}$ , such that  $f(3) \geq f(9) \geq f(15) \geq f(21) \geq \dots \geq f(99)$ , is \_\_\_\_\_

- (A)  ${}^{50}P_{17}$  (B)  ${}^{50}P_{33}$   
(C)  $33! \times 17!$  (D)  $\frac{50!}{2}$

Official Ans. by NTA (B)

4. The remainder when  $(11)^{1011} + (1011)^{11}$  is divided by 9 is

- (A) 1 (B) 4  
(C) 6 (D) 8

Official Ans. by NTA (D)

5. The sum  $\sum_{n=1}^{21} \frac{3}{(4n-1)(4n+3)}$  is equal to

- (A)  $\frac{7}{87}$  (B)  $\frac{7}{29}$   
(C)  $\frac{14}{87}$  (D)  $\frac{21}{29}$

Official Ans. by NTA (B)

6.  $\lim_{x \rightarrow \frac{\pi}{4}} \frac{8\sqrt{2} - (\cos x + \sin x)^7}{\sqrt{2} - \sqrt{2} \sin 2x}$  is equal to

- (A) 14 (B) 7  
(C)  $14\sqrt{2}$  (D)  $7\sqrt{2}$

Official Ans. by NTA (A)

7.  $\lim_{n \rightarrow \infty} \frac{1}{2^n} \left( \frac{1}{\sqrt{1-\frac{1}{2^n}}} + \frac{1}{\sqrt{1-\frac{2}{2^n}}} + \frac{1}{\sqrt{1-\frac{3}{2^n}}} + \dots + \frac{1}{\sqrt{1-\frac{2^n-1}{2^n}}} \right)$

is equal to

- (A)  $\frac{1}{2}$  (B) 1  
(C) 2 (D) -2

Official Ans. by NTA (C)

8. If A and B are two events such that

$$P(A) = \frac{1}{3}, P(B) = \frac{1}{5} \quad \text{and} \quad P(A \cup B) = \frac{1}{2},$$

then  $P(A|B') + P(B|A')$  is equal to

- (A)  $\frac{3}{4}$  (B)  $\frac{5}{8}$   
(C)  $\frac{5}{4}$  (D)  $\frac{7}{8}$

Official Ans. by NTA (B)



9. Let  $[t]$  denote the greatest integer less than or equal to  $t$ . Then the value of the integral

$$\int_{-3}^{101} ([\sin(\pi x)] + e^{\cos(2\pi x)}) dx \text{ is equal to}$$

- (A)  $\frac{52(1-e)}{e}$  (B)  $\frac{52}{e}$   
 (C)  $\frac{52(2+e)}{e}$  (D)  $\frac{104}{e}$

**Official Ans. by NTA (B)**

10. Let the point  $P(\alpha, \beta)$  be at a unit distance from each of the two lines  $L_1 : 3x - 4y + 12 = 0$ , and  $L_2 : 8x + 6y + 11 = 0$ . If  $P$  lies below  $L_1$  and above  $L_2$ , then  $100(\alpha + \beta)$  is equal to

- (A)  $-14$  (B)  $42$   
 (C)  $-22$  (D)  $14$

**Official Ans. by NTA (D)**

11. Let a smooth curve  $y = f(x)$  be such that the slope of the tangent at any point  $(x, y)$  on it is

directly proportional to  $\left(\frac{-y}{x}\right)$ . If the curve passes through the point  $(1, 2)$  and  $(8, 1)$ , then

$$\left|y\left(\frac{1}{8}\right)\right| \text{ is equal to}$$

- (A)  $2\log_e 2$  (B)  $4$   
 (C)  $1$  (D)  $4\log_e 2$

**Official Ans. by NTA (B)**

12. If the ellipse  $\frac{x^2}{a^2} + \frac{y^2}{b^2} = 1$  meets the line

$$\frac{x}{7} + \frac{y}{2\sqrt{6}} = 1 \text{ on the } x\text{-axis and the line}$$

$$\frac{x}{7} - \frac{y}{2\sqrt{6}} = 1 \text{ on the } y\text{-axis, then the eccentricity of the ellipse is}$$

- (A)  $\frac{5}{7}$  (B)  $\frac{2\sqrt{6}}{7}$   
 (C)  $\frac{3}{7}$  (D)  $\frac{2\sqrt{5}}{7}$

**Official Ans. by NTA (A)**

13. The tangents at the point  $A(1, 3)$  and  $B(1, -1)$  on the parabola  $y^2 - 2x - 2y = 1$  meet at the point  $P$ . Then the area (in unit<sup>2</sup>) of the triangle  $PAB$  is :-

- (A)  $4$  (B)  $6$   
 (C)  $7$  (D)  $8$

**Official Ans. by NTA (D)**

14. Let the foci of the ellipse  $\frac{x^2}{16} + \frac{y^2}{7} = 1$  and the

hyperbola  $\frac{x^2}{144} - \frac{y^2}{\alpha} = \frac{1}{25}$  coincide. Then the length of the latus rectum of the hyperbola is:-

- (A)  $\frac{32}{9}$  (B)  $\frac{18}{5}$   
 (C)  $\frac{27}{4}$  (D)  $\frac{27}{10}$

**Official Ans. by NTA (D)**

15. A plane  $E$  is perpendicular to the two planes  $2x - 2y + z = 0$  and  $x - y + 2z = 4$ , and passes through the point  $P(1, -1, 1)$ . If the distance of the plane  $E$  from the point  $Q(a, a, 2)$  is  $3\sqrt{2}$ , then  $(PQ)^2$  is equal to

- (A)  $9$  (B)  $12$   
 (C)  $21$  (D)  $33$

**Official Ans. by NTA (C)**

16. The shortest distance between the lines

$$\frac{x+7}{-6} = \frac{y-6}{7} = z \text{ and } \frac{7-x}{2} = y-2 = z-6 \text{ is}$$

- (A)  $2\sqrt{29}$  (B)  $1$   
 (C)  $\sqrt{\frac{37}{29}}$  (D)  $\frac{\sqrt{29}}{2}$

**Official Ans. by NTA (A)**

17. Let  $\vec{a} = \hat{i} - \hat{j} + 2\hat{k}$  and  $\vec{b}$  be a vector such that  $\vec{a} \times \vec{b} = 2\hat{i} - \hat{k}$  and  $\vec{a} \cdot \vec{b} = 3$ . Then the projection of  $\vec{b}$  on the vector  $\vec{a} - \vec{b}$  is :-

- (A)  $\frac{2}{\sqrt{21}}$                       (B)  $2\sqrt{\frac{3}{7}}$   
 (C)  $\frac{2}{3}\sqrt{\frac{7}{3}}$                       (D)  $\frac{2}{3}$

**Official Ans. by NTA (A)**

18. If the mean deviation about median for the number 3, 5, 7, 2k, 12, 16, 21, 24 arranged in the ascending order, is 6 then the median is

- (A) 11.5                      (B) 10.5  
 (C) 12                      (D) 11

**Official Ans. by NTA (D)**

19.  $2\sin\left(\frac{\pi}{22}\right)\sin\left(\frac{3\pi}{22}\right)\sin\left(\frac{5\pi}{22}\right)\sin\left(\frac{7\pi}{22}\right)\sin\left(\frac{9\pi}{22}\right)$

is equal to

- (A)  $\frac{3}{16}$                       (B)  $\frac{1}{16}$   
 (C)  $\frac{1}{32}$                       (D)  $\frac{9}{32}$

**Official Ans. by NTA (B)**

20. Consider the following statements :

P : Ramu is intelligent

Q : Ramu is rich

R : Ramu is not honest

The negation of the statement "Ramu is intelligent and honest if and only if Ramu is not rich" can be expressed as :

- (A)  $((P \wedge (\sim R)) \wedge Q) \wedge ((\sim Q) \wedge ((\sim P) \vee R))$   
 (B)  $((P \wedge R) \wedge Q) \vee ((\sim Q) \wedge ((\sim P) \vee (\sim R)))$   
 (C)  $((P \wedge R) \wedge Q) \wedge ((\sim Q) \wedge ((\sim P) \vee (\sim R)))$   
 (D)  $((P \wedge (\sim R)) \wedge Q) \vee ((\sim Q) \wedge ((\sim P) \vee R))$

**Official Ans. by NTA (D)**

**SECTION-B**

1. Let  $A = \{1, 2, 3, 4, 5, 6, 7\}$ . Define  $B = \{T \subseteq A : \text{either } 1 \notin T \text{ or } 2 \in T\}$  and  $C = \{T \subseteq A : \text{sum of all the elements of } T \text{ is a prime number}\}$ . Then the number of elements in the set  $B \cup C$  is \_\_\_\_\_

**Official Ans. by NTA (107)**

2. Let  $f(x)$  be a quadratic polynomial with leading coefficient 1 such that  $f(0) = p$ ,  $p \neq 0$  and  $f(1) = \frac{1}{3}$ . If the equation  $f(x) = 0$  and  $f(f(f(x))) = 0$  have a common real root, then  $f(-3)$  is equal to.....

**Official Ans. by NTA (25)**

3. Let  $A = \begin{bmatrix} 1 & a & a \\ 0 & 1 & b \\ 0 & 0 & 1 \end{bmatrix}$ ,  $a, b \in \mathbb{R}$ . If for some  $n \in \mathbb{N}$ ,

$A^n = \begin{bmatrix} 1 & 48 & 2160 \\ 0 & 1 & 96 \\ 0 & 0 & 1 \end{bmatrix}$  then  $n + a + b$  is equal to

**Official Ans. by NTA (24)**

4. The sum of the maximum and minimum values of the function  $f(x) = |5x - 7| + [x^2 + 2x]$  is the

interval  $\left[\frac{5}{4}, 2\right]$ , where  $[t]$  is the greatest integer  $\leq t$  is \_\_\_\_\_

**Official Ans. by NTA (15)**

5. Let  $y = y(x)$  be the solution of the differential equation  $\frac{dy}{dx} = \frac{4y^3 + 2yx^2}{3xy^2 + x^3}$ ,  $y(1) = 1$ . If for some  $n \in \mathbb{N}$ ,  $y(2) \in [n-1, n)$ , then  $n$  is equal to \_\_\_\_\_

**Official Ans. by NTA (3)**

**Final JEE-Main Exam July, 2022/25-07-2022/Evening Session**

6. Let  $f$  be a twice differentiable function on  $\mathbb{R}$ .  
If  $f'(0) = 4$  and

$$f(x) + \int_0^x (x-t)f'(t)dt = (e^{2x} + e^{-2x})\cos 2x + \frac{2}{a}x,$$

then  $(2a + 1)^5 a^2$  is equal to \_\_\_\_\_

**Official Ans. by NTA (8)**

7. Let  $a_n = \int_{-1}^n \left( 1 + \frac{x}{2} + \frac{x^2}{2} + \frac{x^3}{3} + \dots + \frac{x^{n-1}}{n} \right) dx$

for  $n \in \mathbb{N}$ . Then the sum of all the elements of the set  $\{n \in \mathbb{N} : a_n \in (2, 30)\}$  is \_\_\_\_\_

**Official Ans. by NTA (5)**

8. If the circles  $x^2 + y^2 + 6x + 8y + 16 = 0$  and  $x^2 + y^2 + 2(3 - \sqrt{3})x + x + 2(4 - \sqrt{6})y = k + 6\sqrt{3} + 8\sqrt{6}$ ,  $k > 0$ , touch internally at the point  $P(\alpha, \beta)$ , then  $(\alpha + \sqrt{3})^2 + (\beta + \sqrt{6})^2$  is equal to \_\_\_\_\_

**Official Ans. by NTA (25)**

9. Let the area enclosed by the  $x$ -axis, and the tangent and normal drawn to the curve  $4x^3 - 3xy^2 + 6x^2 - 5xy - 8y^2 + 9x + 14 = 0$  at the point  $(-2, 3)$  be  $A$ . Then  $8A$  is equal to \_\_\_\_\_

**Official Ans. by NTA (170)**

10. Let  $x = \sin(2 \tan^{-1} \alpha)$  and  $y = \sin\left(\frac{1}{2} \tan^{-1} \frac{4}{3}\right)$ . If

$$S = \{\alpha \in \mathbb{R} : y^2 = 1 - x\}, \text{ then } \sum_{\alpha \in S} 16\alpha^3 \text{ is equal to}$$

\_\_\_\_\_

**Official Ans. by NTA (130)**